

# LI-7810 CH<sub>4</sub>/CO<sub>2</sub>/H<sub>2</sub>O Trace Gas Analyzer

## Instruction Manual



**LI-COR**<sup>®</sup>



# LI-7810 CH<sub>4</sub>/CO<sub>2</sub>/H<sub>2</sub>O

## Trace Gas Analyzer

Instruction Manual

**LI-COR Biosciences**

4647 Superior Street  
Lincoln, Nebraska 68504  
Phone: +1-402-467-3576  
Toll free: 800-447-3576 (U.S. and Canada)  
envsales@licor.com

***Regional Offices***

**LI-COR Biosciences GmbH**

Siemensstraße 25A  
61352 Bad Homburg  
Germany  
Phone: +49 (0) 6172 17 17 771  
envsales-gmbh@licor.com

**LI-COR Biosciences UK Ltd.**

St. John's Innovation Centre  
Cowley Road  
Cambridge  
CB4 0WS  
United Kingdom  
Phone: +44 (0) 1223 422102  
envsales-UK@licor.com

**LI-COR Distributor Network:**

[www.licor.com/env/distributors](http://www.licor.com/env/distributors)

***LI-COR***<sup>®</sup>

## Notice

The information in this document is subject to change without notice.

LI-COR MAKES NO WARRANTY OF ANY KIND WITH REGARD TO THIS MATERIAL, INCLUDING BUT NOT LIMITED TO THE IMPLIED WARRANTIES OF MERCHANTABILITY AND FITNESS FOR A PARTICULAR PURPOSE. LI-COR shall not be held liable for errors contained herein or for incidental or consequential damages in connection with the furnishing, performance, or use of this material.

This document contains proprietary information, which is protected by copyright. All rights are reserved. No part of this document may be photocopied, reproduced, or translated to another language without prior written consent of LI-COR, Inc.

PreciseTech™ Design is a trademark of LI-COR, Inc. Microsoft, Windows, and Excel are registered trademarks of the Microsoft Corporation. Wi-Fi is a trademark of the Wi-Fi Alliance. All other trademarks and registered trademarks are property of their respective owners.

This product is protected by U.S. patents 8,659,758, 8,665,442, 8,885,167, 9,116,047, 9,194,742, 9,304,080, 9,581,492, 9,678,003, 9,759,654, 9,759,655, 9,989,729, and 10,060,942. Additional patents pending in the U.S. and other countries.

## Printing History





© Copyright 2019, LI-COR, Inc. All rights reserved.

Publication Number: 984-17414

Created on: Friday, March 8, 2019.

## Notes on Safety

This LI-COR product has been designed to be safe when operated in the manner described in this manual. The safety of this product cannot be assured if the product is used in any other way than is specified in this manual. The product is intended to be used by qualified personnel. Read this entire manual before using the product.

Equipment markings:	
	The product is marked with this symbol when it is necessary for you to refer to the manual or accompanying documents in order to protect against injury or damage to the product.
	The product is marked with this symbol when a hazardous voltage may be present.
	The product is marked with this symbol if a Chassis Ground connection is required.
	The product is marked with this symbol to indicate that a direct current (DC) power supply is required.
<b>WARNING</b>	Warnings must be followed carefully to avoid bodily injury.
<b>CAUTION</b>	Cautions must be observed to avoid damage to your equipment.
Manual markings:	
<b>Warning</b>	Warnings must be followed carefully to avoid bodily injury.
<b>Caution</b>	Cautions must be observed to avoid damage to your equipment.
<b>Note</b>	Notes contain important information and useful tips on the operation of your equipment.



## CE Marking:

This product is a CE-marked product. For conformity information, contact LI-COR Support at [envsupport@licor.com](mailto:envsupport@licor.com). Outside of the U.S., contact your local sales office or distributor.

## California Proposition 65 Warning

---



**Warning:** *This product can expose you to chemicals including Nickel, which is known to the State of California to cause cancer. For more information go to [www.P65Warnings.ca.gov](http://www.P65Warnings.ca.gov).*

---

## Federal Communications Commission Radio Interference Statement

**WARNING:** This equipment generates, uses, and can radiate radio frequency energy and if not installed in accordance with the instruction manual, may cause interference to radio communications. It has been tested and found to comply with the limits for a Class A computing device pursuant to Subpart J of Part 15 of FCC rules, which are designed to provide a reasonable protection against such interference when operated in a commercial environment. Operation of this equipment in a residential area is likely to cause interference in which case the user, at his own expense, will be required to take whatever measures may be required to correct the interference.

## Waste Electronic and Electrical Equipment (WEEE) Notice

This symbol indicates that the product is to be collected separately from unsorted municipal waste. The following applies to users in European countries: This product is designated for separate collection at an appropriate collection point. Do not dispose of as household waste. For more information, contact your local distributor or the local authorities in charge of waste management.



## Acknowledgments

The initial principles and some portions of the technology presented herein were developed in part based on a grant from the MONITOR Program by the U.S. Department of Energy Advanced Research Projects Agency - Energy (ARPA-E), under award number DE-AR0000537.



# Contents

Preface .....	viii
---------------	------

## Section 1. What's What

---

Gas analyzer .....	1-1
Rechargeable batteries .....	1-3
Universal power supply .....	1-3
Ethernet cable .....	1-4
Accessory kit .....	1-4
Auxiliary power supply adapter .....	1-5
Backpack kit .....	1-5

## Section 2. Getting Started

---

Powering on the instrument .....	2-1
Connecting with the instrument .....	2-1
Connecting over a local network .....	2-2
Connecting over wireless .....	2-4
Power options .....	2-6
Universal power supply .....	2-6
Rechargeable batteries .....	2-6
External power source .....	2-7
Instrument display .....	2-8
Status codes .....	2-9
Powering off the instrument .....	2-10
Storing the instrument .....	2-10
Shipping the instrument .....	2-11

## Section 3. Applications of the LI-7810

---

Flow schematic .....	3-1
Connecting the air inlet and outlet .....	3-2
Plumbing a subsample .....	3-3
Retrieving data from the instrument .....	3-4
Downloading a data file .....	3-4
Components of the data file .....	3-5
Installing the instrument in a rack mount .....	3-7

## Section 4. Software overview

---

Home page .....	4-1
Layouts .....	4-3
Thresholds .....	4-4
Network .....	4-5
Software Version .....	4-5
Time Setup .....	4-5
Network .....	4-6
Wi-Fi .....	4-6
Settings .....	4-8
Power .....	4-8
Battery Status .....	4-8
Network Status .....	4-8
Performance status indicators .....	4-8
Performance monitor .....	4-9
Advanced .....	4-10

## Section 5. Troubleshooting

---

Unable to connect with the instrument over a wired connection .....	5-1
Unable to connect with the instrument over a wireless connection .....	5-3
The interface is in a language that I don't understand .....	5-4
Readings drift or step change unexpectedly .....	5-4
Graphed data overlaps in time or has gaps .....	5-4
Pressure readings are questionable or unstable .....	5-5

## Section 6. Maintenance

---

Instrument calibration .....	6-1
Setting the zero .....	6-2
Setting the span .....	6-3
Recovering from a bad calibration .....	6-3
Replacing the air inlet filter .....	6-4
Replacing the purge dry-down chemical .....	6-5

## Appendix A. Measurement overview

---

## Appendix B. Additional safety information

---

**Appendix C. Specifications**

---

**Appendix D. Warranty**

---

**Appendix E. Index**

---

## Preface

This document provides basic operating instructions for the LI-7810 gas analyzer running software version 2.0.

We have made every effort to ensure that this document accurately represents the instrument. As with any software-dependent instrument, development continues after the documentation goes to press. As a result, small inconsistencies between the documentation and the instrument may be present.

Updates to this document, as well as application notes, technical literature, videos that support the product, and software updates, will be available from [licor.com/env/support](http://licor.com/env/support) (search for LI-7810).

We appreciate feedback on this manual. Send your comments to [envfeedback@licor.com](mailto:envfeedback@licor.com).

For technical support with the product, go to [licor.com/env/support](http://licor.com/env/support) or email [envsupport@licor.com](mailto:envsupport@licor.com).

# Section 1.

## What's What

---

The LI-7810 CH<sub>4</sub>/CO<sub>2</sub>/H<sub>2</sub>O Trace Gas Analyzer is a high-precision, high-stability, laser-based gas analyzer that uses Optical Feedback — Cavity-Enhanced Absorption Spectroscopy (OF-CEAS) to measure gases in air. OF-CEAS is a well-established spectroscopic technique that is described in published literature. See *Measurement overview* on page A-1 for a brief summary of OF-CEAS.

If you have just taken delivery of the instrument, check your packing list to be sure you received everything that you ordered. The LI-7810 includes some or all of the following components.

### Gas analyzer



The gas analyzer is in a gray enclosure. It is designed for indoor and outdoor use but it is not waterproof. It should not be allowed to sit in standing water, exposed to driving rain, or deployed outdoors without weather protection.

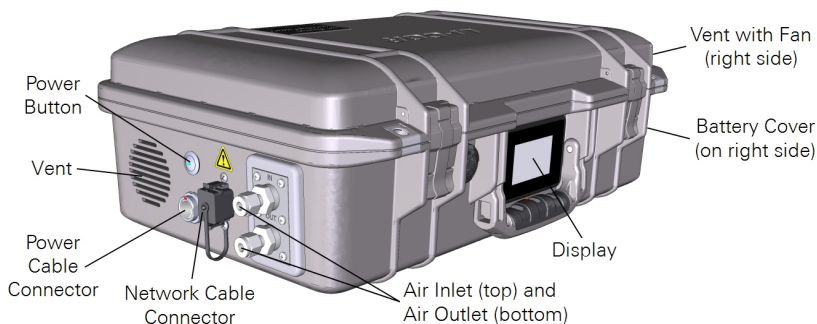

The components of the analyzer are described below, followed by the remaining accessories.

### Power button

The power button is used to power the instrument on and off and enter and exit sleep mode. It has an indicator light that will be illuminated when the instrument is powered on and dark when it is powered off. Functions of the button are described in *Powering on the instrument* on page 2-1 and *Powering off the instrument* on page 2-10.

### Power cable connector

The power cable connector is compatible with the included AC power supply and the optional power adapter cable (part number 9968-242).



**Warning:** Use the safety-approved power cord supplied with the instrument. The instrument power supply is equipped with a 3-wire grounding plug. This plug will only fit into a grounded outlet. Do not defeat the purpose of the grounding-type plug. Do not place the instrument where the power cord will be walked on or exposed to water or chemical spills.

**Avertissement:** Utilisez le cordon d'alimentation approuvé pour la sécurité fourni avec l'instrument. L'alimentation de l'instrument est équipée d'une fiche de terre à 3 fils. Cette fiche ne rentrera que dans une prise de terre. N'allez pas à l'envers de la fonction de la fiche de mise à la terre. Ne placez pas l'instrument où le cordon d'alimentation sera piétiné ou exposé à l'eau ou aux déversements de produits chimiques.

---

### Network cable connector

The network cable connector is compatible with standard RJ-45 Ethernet cables.

### Air inlet

The instrument draws air in through the inlet using the internal pump. The inlet connector is a compression fitting, which is compatible with 1/4" outside diameter tubes. Additional nuts and ferrule sets are include in the accessories kit.



**Warning:** Do not exceed the maximum absolute pressure rating of 110 kPa.

**Avertissement:** Ne dépassez pas la pression nominale absolue maximale de 110 kPa.

---

### Air outlet

The instrument exhausts air through the outlet after it is measured. Do not substantially restrict or apply a vacuum to the outlet.



## Rechargeable batteries

Part Number  
442-11807

Two batteries are provided with the instrument. We recommend leaving at least one battery in the instrument when you are using it. The batteries are 14.4 V lithium ion battery packs with 6.8 amp-hour capacity. Two batteries can provide up to 8 hours of operation under most conditions. Batteries are shipped in a partially discharged state. They should be fully charged prior to the first use. Storing the batteries in a discharged state can result in damage to the batteries. Batteries that are installed in the instrument will be charged when the instrument is connected to an AC power supply.



**Warning:** *Lithium ion batteries may cause environmental damage or damage to human health if they are disposed of improperly. Do not dispose of the batteries in unsorted municipal waste or an incinerator. Many localities have battery recycling facilities that will accept lithium ion batteries. Check your local regulations to determine how to safely dispose of the batteries.*

**Advertissment:** *Les batteries lithium ion peuvent causer des dommages à l'environnement ou endommager la santé humaine si l'on se débarrasse d'elles de manière inappropriée. Ne vous débarrassez pas des batteries dans des déchets municipaux non triés ou dans un incinérateur. Plusieurs localités ont des installations de recyclage de batteries qui accepteront les batteries lithium ion. Vérifiez vos réglementations locales pour déterminer comment se débarrasser des batteries en toute sécurité.*

## Universal power supply

Part Number  
9968-232

The universal power supply powers the instrument and charges the batteries when it is plugged into an AC power supply. The power supply provides an output of 24 VDC (9.17 Amps maximum; 220 Watts maximum). It is compatible with 100 to 240 VAC, 50 to 60 Hz power. The power supply can accept a C13 coupler (called an IEC cord). The instrument will include one of the cords listed in *Table 1-1* on the next page.

**Table 1-1.** Power cables for the power supply.

Description	Part Number
For USA, Canada, Mexico, and Japan; NEMA 5-15; Type B	390-00787
For Europe, South America, and Asia; CEE 7/7; Type C	390-01486
For United Kingdom; Type G	390-03089

**Table 1-1.** Power cables for the power supply. (...continued)

Description	Part Number
For Israel; SI32; Type H	390-03059
For Australia; Type I	390-03095

 **Warning:** Use the safety-approved power cord supplied with the instrument. The instrument power supply is equipped with a 3-wire grounding plug. This plug will only fit into a grounded outlet. Do not defeat the purpose of the grounding-type plug. Do not place the instrument where the power cord will be walked on or exposed to water or chemical spills.

**Avertissement:** Utilisez le cordon d'alimentation approuvé pour la sécurité fourni avec l'instrument. L'alimentation de l'instrument est équipée d'une fiche de terre à 3 fils. Cette fiche ne rentrera que dans une prise de terre. N'allez pas à l'envers de la fonction de la fiche de mise à la terre. Ne placez pas l'instrument où le cordon d'alimentation sera piétiné ou exposé à l'eau ou aux déversements de produits chimiques.

## Ethernet cable

Part Number  
616-06116

Network cable with RJ-45 connectors (Cat5e); to connect the instrument to a computer or network. Length of 2.1 meters (7 feet).

**Note:** Do not use cables other than the one provided. Other cables may result in improper electrical performance.

## Accessory kit

Part Number  
9978-195

The accessory kit includes some accessories and replacement components that may be useful to you. Additional replacement parts are available from LI-COR or your local distributor.

Description	Quantity	Part Number
Replacement dry-down chemical pack (17 grams each)	3	622-17627
Stainless Steel Screws ; M3×0.5; 8 mm	6	150-14419
O-ring; 27×1.5 mm	2	192-16956
O-ring; 22×2.5 mm	4	192-17345
Stainless Steel 1/4" Ferrule and Nut Set	5	300-15025
Filter support disks	2	9878-280
Filter pack (5 filters)	1	9978-193

## Auxiliary power supply adapter

Part Number  
9968-242

This optional component allows you to power the instrument from an external DC power supply, such as a deep cycle battery. It has a connector for the instrument power connection and bare leads for a power source. Power requirements are given in *Applications of the LI-7810* on page 3-1.

## Backpack kit

Part Number  
610-17341

The backpack kit is an optional accessory that can be used to carry the instrument. It is a Tecra Tools backpack harness with a padded back, padded shoulder straps, lumbar support, and a padded waist belt.

The analyzer is secured in the backpack with several straps. The bottom of the instrument will be against your back. The tubes can face up or down. Use caution with the backpack kit:

- Close the clasps and tighten the straps so that the instrument is secure.
- Do not block the vents or set the instrument in standing water.
- If you are unable to lift the backpack kit comfortably, consider enlisting the help of a "strapping" assistant.
- Clip the chest and waist straps. Tighten all of the straps snugly.

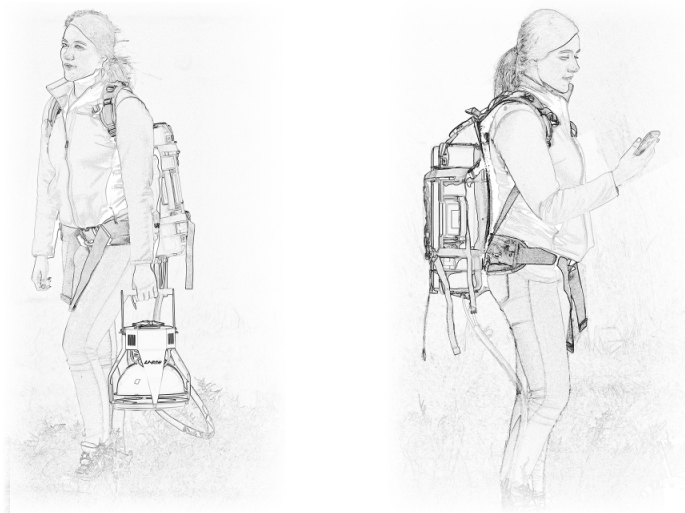



## Section 2.

# Getting Started

---

This section provides basic operating instructions for the instrument.

## Powering on the instrument

To power on the instrument, connect a power supply (see *Power options* on page 2-6) and then press and release the power button. As the instrument warms up, it will initialize and it will issue a series of status codes until it completes the start up cycle. The pump will start running when the optical bench nears the temperature setpoint of 55 °C. If starting from room temperature, it will take about 20 minutes before you can connect, and another 10 or 15 minutes to finish warming up before it provides accurate measurements. If the instrument is very cold, it will take longer to warm up.

The instrument cannot be powered on remotely. You can restart the instrument through the interface, but if the instrument powers off for any reason, you must press the power button to turn it back on. See *Power options* on page 2-6 for additional details.

## Connecting with the instrument

The LI-7810 has a built-in web server, meaning that it does not require external software. All you need is a PC (running Windows, macOS, or Linux), a tablet, or a mobile device (running iOS or Android OS) that is connected to the same network as your instrument, and a web browser. Chrome, Firefox, or Safari are supported browsers. Other browsers may work, or they may not.

## Connecting over a local network

Follow these steps to connect to an instrument that has a wired connection, either directly to your computer or to a local area network.

### 1 Power on the instrument

If you are starting the instrument from room temperature, it will take about 20 minutes to start up before you can connect, and another 10 or 15 minutes to finish warming up before it provides accurate measurements. You can connect before the instrument is warmed up. The instrument status is given on the instrument display panel.

### 2 Connect a network cable between the instrument and your local network

Install a network cable between the instrument and a vacant network port on your local network or directly to your computer's network port (the instrument and your computer must be on the same network). The instrument will indicate that it is on a network by displaying the network icon (☐☐). If your local area network also has a wireless network (Wi-Fi), you can connect to your instrument over the wireless network.

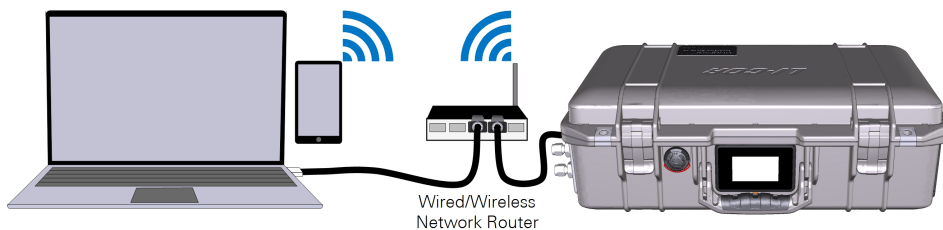

### 3 Enter the hostname or IP address in a web browser address bar

Both the hostname (which is the instrument serial number) and IP address are given on the display. Type one or the other into the address bar:

- Hostname: Enter `http://tg10-nnnnnn.local`, where `tg10-nnnnnn` is the hostname (and the serial number) of your instrument.
- IP Address: For example: `http://172.24.80.54`. Yours will probably be different.

Press **Enter** to connect.

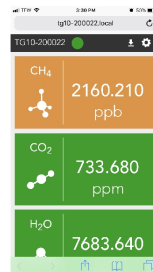
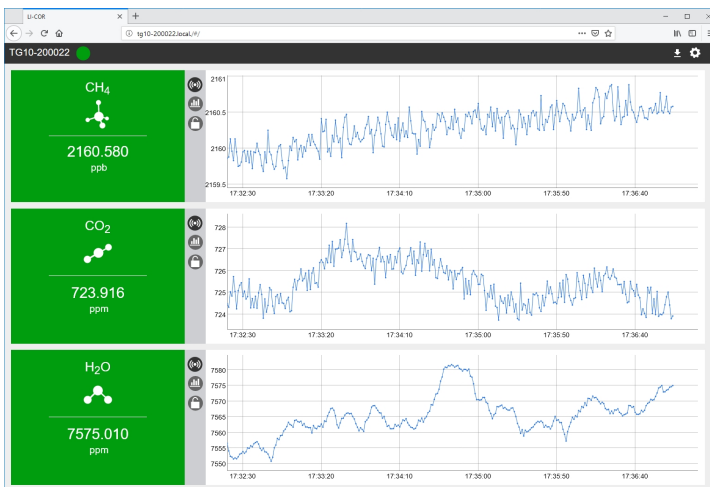

If you are unable to connect, see *Unable to connect with the instrument over a wired connection* on page 5-1 to troubleshoot the issue.

## Connecting over wireless

Follow these steps to connect to the instrument's wireless network.

**Note:** This product is capable of creating a Wireless Local Area Network (WLAN). The use of WLAN is restricted in some regions and countries. The illegal use of WLAN may be punishable under these regulations. Check your local regulations to determine if WLAN is permitted. LI-COR, Inc. cannot be held liable for any problems arising from the use of WLAN in any countries or regions. Legal penalties may result from any of the following:

- Enabling a wireless network where it is not permitted
- Modifying or altering the product
- Removing the certification labels from the product

### 1 Connect over a wired network and turn on the instrument Wi-Fi

Follow the steps in *Connecting over a local network* on page 2-2. Then click **Network**. Set **Wi-Fi** to **ON** and click **Update**.

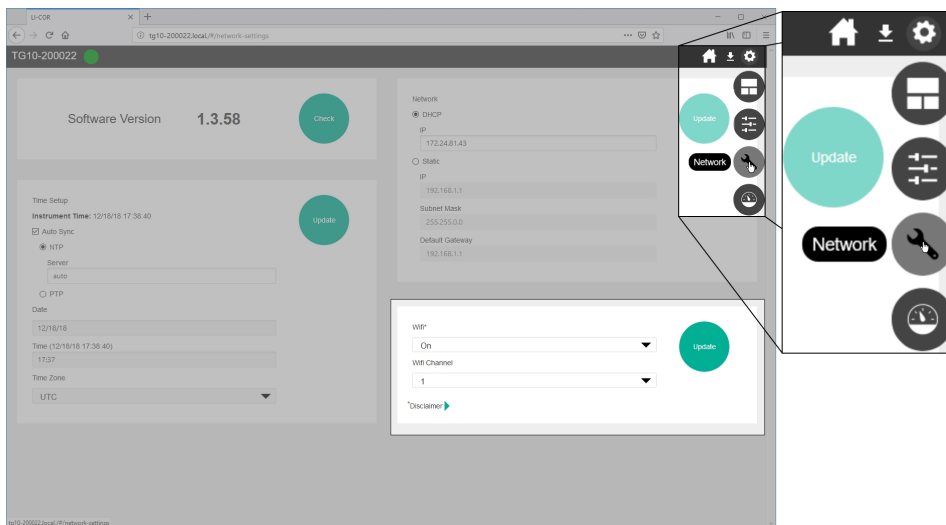



## 2 Connect your PC or mobile device to the instrument wireless network

When Wi-Fi is enabled, LI-7810 will make a local wireless network, indicated by the presence of a wireless network symbol (📶) on the display. Find the network in the list of networks presented on your device. The *network name is the hostname (and serial number) of the instrument*. The password is `licorenv`. Connect your computer or mobile device to the network.



## 3 Enter the hostname or IP address in a web browser address bar

The hostname (the serial number) and IP address are given on the display.

- Hostname: Enter `http://tg10-nnnnnn.local` where `tg10-nnnnnn` is the hostname (and the serial number) of your instrument.
- IP Address: For example: `http://172.24.80.54`. Yours will probably be different.

Press Enter to connect.

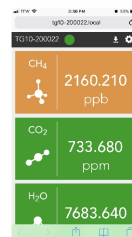
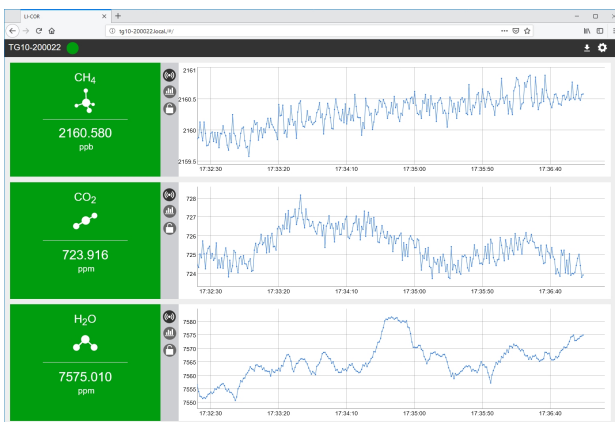

If you are unable to connect, see *Unable to connect with the instrument over a wireless connection* on page 5-3 to troubleshoot the issue.

## Power options

The instrument can be powered in one of three ways: the universal power supply, rechargeable batteries, or from an external power source using the optional power supply cable.

### Universal power supply

The AC universal power supply is compatible with 100 to 240 VAC power sources, both 50 and 60 Hz input. It outputs 24 VDC. The power supply also charges the batteries that are installed in the instrument.

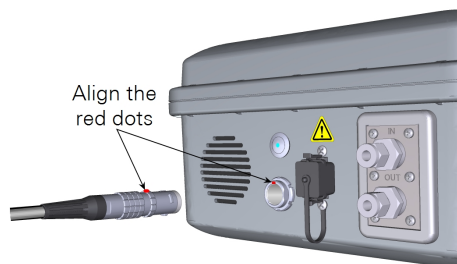

### Rechargeable batteries

The batteries install behind the battery cover. Only one battery is required to power the instrument. The instrument supports hot-swapping, meaning that you can remove one battery and replace it with another and measurements will not be disrupted — as long as the instrument is still powered by a charged battery or the universal power supply.

The batteries are not user serviceable. If a battery exceeds a temperature or load threshold, a non-resettable fuse will open, rendering the battery non-functional. If the batteries become excessively discharged in storage, the charger will supply a 3-minute wake-up charge in an attempt to activate the electronics.

### Charging batteries in the instrument

If batteries are installed in the instrument, they will charge any time the instrument is powered from the universal power supply or another 24 VDC power supply on pins 1 and 5 (*Table 2-1* on the facing page). The 10.5 to 33 VDC power terminals (pins 3 and 4; *Table 2-1* on the facing page) do not charge the batteries.

The charge status of batteries is given in the web interface, the instrument display, and on the battery charge gauge.

Charge Gauge

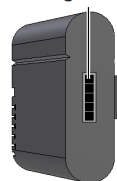

## Charging batteries with an external charger

The optional single-bay charger (part number 590-11830; Inspired Energy CH7000A) can charge one battery at a time. To use the charger, plug it into a wall socket and place a battery in the dock. The charger is compatible with 100 to 240 VAC power at 50 to 60 Hz. When charging, you'll see a blinking LED. When fully charged, you'll see a solid green LED.

**Note:** You can use the optional automobile adapter kit to charge the battery from an automobile. Leave the vehicle running when charging the battery to prevent excessive discharge of the car battery.

 **Warning:** Charge batteries only with a SMBUS compliant level 2 or 3 charger. Do not heat above 80 °C. Do not open battery, dispose of in fire, or short circuit—may ignite, explode, leak, or get hot, causing personal injury. Replace battery with same part number only. Use of another battery may present a risk of fire or explosion. Keep away from children.

**Avertissement:** Ne rechargez les batteries qu'avec un chargeur conforme au SMBUS niveau 2 ou 3. Ne chauffez pas au-dessus de 80 °C. Ne pas ouvrir la batterie, ni ne la jeter au feu ou court-circuiter—elle peut mettre à feu, exploser, couler, ou s'échauffer, causant des blessures personnelles. Remplacez les batteries seulement avec le même numéro de pièce. L'utilisation d'une autre batterie peut présenter un risque, ou un incendie ou une explosion. A garder hors de portée des enfants.

## External power source

You can power the instrument with any 10.5 to 30 VDC power source. A deep-cycle marine battery with at least a 20 amp-hour capacity will work fine. An external power source can be connected using the optional adapter cable (part number 9968-242).

**Table 2-1.** Power inputs for the auxiliary power supply connector.

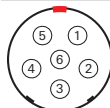
Connector	Pins	
	1 and 5	== 24 VDC; 6 Amps; LI-COR power source
	3 and 4	== 10.5 to 33 VDC; 8 Amps
	2 and 6	Ground

## Instrument display

The instrument display panel provides useful information at a glance.

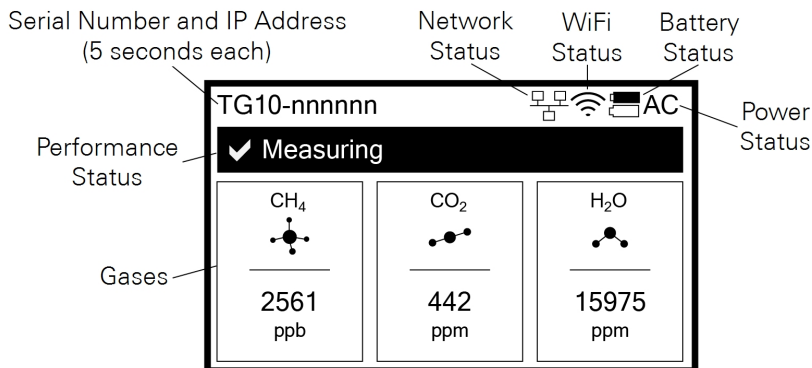

**Serial Number:** TG10-nnnnnn; The instrument serial number. The serial number is also printed on the case label. The serial number and IP Address are each displayed for 5 seconds.

**IP Address:** The instrument Internet Protocol address (IPv4) is displayed for 5 seconds. If the instrument is not connected to a network, it will display IP:down instead.

**Network Status:** When visible (☐☐), the instrument is connected to a network. The network cable is installed between the instrument network port and a port on a local area network.

**Wi-Fi Status:** When visible (📶), indicates that the wireless network is enabled.

**Battery Status:** Indicates the charge status (🔋). A solid black battery indicates a full charge; an outline indicates a discharged battery. The battery icon is not displayed when no batteries are installed.

**Power Status:** Indicates the power source (AC if power cable connected).



















**Performance Status:** Indicates performance status of the instrument (see *Status codes* on the facing page).

**Gases:** The gases measured and their concentrations.

## Status codes

Status codes are given on the instrument display panel, software interface, and recorded in the data set, where they are associated with measurements.

**Table 2-2.** Status codes provide information about the performance status of the instrument.

Display Indicator	Software Indicator	Status Code	Definition
	 Green	0	Normal operation (measuring)
	 Yellow	1	Start frequency adjustment; Measurements may be noisy
	 Yellow	2	Laser temperature adjustment; Measurements may be noisy
	 Yellow	4	Incomplete scan resulted in missing cavity modes; Measurements may be noisy
	 Yellow	8	Start-up mode finished; Measurements may be noisy
	 Yellow	16	Start-up mode initializing; Measurements may be noisy
	 Red	32	Spectral fit residual RMS too high; Measurements are invalid
	 Red	64	Unregulated pressures or temperatures; Measurements are invalid
	 Red	128	Instrument not ready; Measurements are invalid

Status codes are additive: if multiple codes are active, the displayed value is the sum of the codes. For example, a display code of 23 indicates that the instrument is initializing the start-up mode (16), it has an incomplete scan (4), laser temperature adjustment is underway (2), and a start frequency adjustment is underway (1).

Non-zero status codes are displayed during warmup and any time the instrument is not in a normal state. Typically, status codes will be resolved by the instrument. Occasionally, you may need to restart the instrument to resolve the code. If your instrument displays a status code that does not resolve itself for several hours or after restarting the instrument, contact technical support.

## Powering off the instrument

The instrument can be powered off with the power button or through the software interface. To **Power Off** the instrument with the button, press it three times within 5 seconds. To enter **Sleep Mode**, press the power button twice within 3 seconds. In sleep mode, the instrument will power off the pump but maintain power to the heaters. Sleep mode is to silence the pumps, if, for example, you want to hear the birds singing while you work. To exit sleep mode, press the power button after waiting at least 5 seconds after the second press. Software power controls are described in *Power* on page 4-8.

**Caution:** While in sleep mode, the instrument will stop drawing in air, which may affect the pressure and flow in your air supply system. Do not enter sleep mode when the air inlet or outlet is subject to positive or negative pressure. Pressures exceeding 110 kPa absolute pressure may damage the instrument.

If a battery becomes depleted during normal operation, the instrument will complete the dry-down cycle before shutting itself down. If the instrument is inadvertently powered off and prevented from completing the dry-down cycle (by removing the batteries and power cable, for example), power it back on and off again so it can complete the dry-down cycle.

**Warning:** Failure to complete the dry-down while powering off the instrument may result in condensation in the optics, which may damage the instrument and require costly repairs.

## Storing the instrument

The instrument can be placed in short-term storage (for several weeks) without any special preparations. For longer-term storage (longer than a month), we recommend that you remove the batteries from the case and clean and dry the instrument exterior with a soft damp (not dripping) cloth and mild detergent if needed. The battery storage temperature range is -20 to 60 °C, <80% relative humidity. The instrument storage temperature is -45 to 50 °C, <85% relative humidity.

## Shipping the instrument

The instrument is delivered with custom-designed foam pad (part number 6578-296) that protects the air inlet and outlet while it is packaged. Keep the foam pad so you can use it to ship the instrument, should the need arise. Cover the air inlet and outlet with the blue caps that were provided with the instrument or scotch tape to keep dust from the filter. Position the foam pad over the inlet and outlet, wrap the instrument with plastic wrap, place it in a large plastic bag, and then tape it tightly so that the foam will stay in place. Place the wrapped instrument in a box with foam packing peanuts.

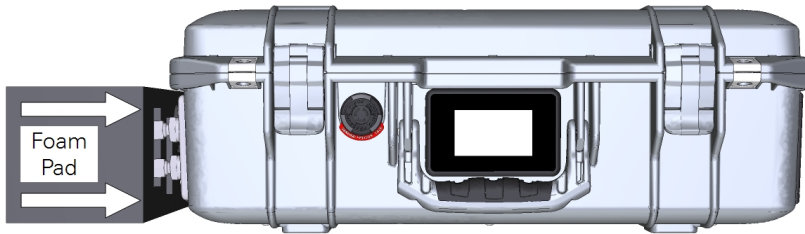

*Figure 2-1. The foam pad protects the inlet, outlet, and network cable connector during shipping. Keep the pad in the event that you need to ship the instrument.*





# Section 3.

## Applications of the LI-7810

In this chapter we provide information about using the instrument in field or laboratory applications. We cover connecting plumbing to the air inlet, retrieving data, and other applications.

### Flow schematic

During normal operation, air is drawn into the analyzer through the air inlet (*Figure 3-1* below). Air flows through the optical bench and phase adjuster and is exhausted through the air outlet. In the optical bench, the pressure is drawn down to about 40 kPa. When the instrument is powering down, air is circulated in a closed loop through the desiccant to ensure that air remaining in the system is free of moisture, preventing condensation when the instrument is powered off.

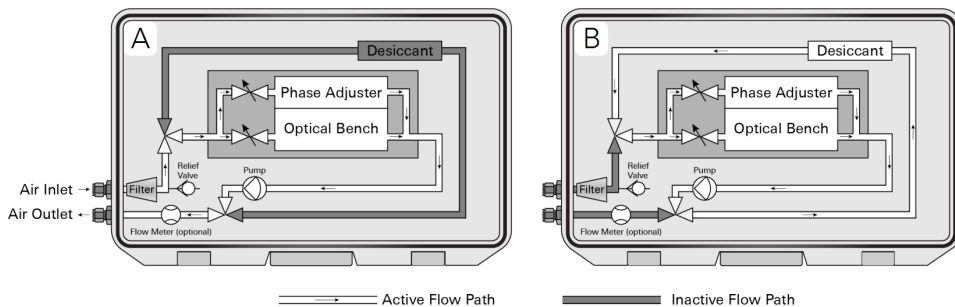

*Figure 3-1. Simplified flow schematic of the LI-7810. During a measurement, (A) air flows through the optical bench and phase adjuster. During shutdown (B), the instrument purges the optical path of water vapor. The flow meter is optional.*

## Connecting the air inlet and outlet

Air is drawn into the sample cell through the air inlet. Connect a ¼" outside diameter metal or plastic tube to the air inlet compression fitting. The nut and ferrule sets are in the accessories kit.

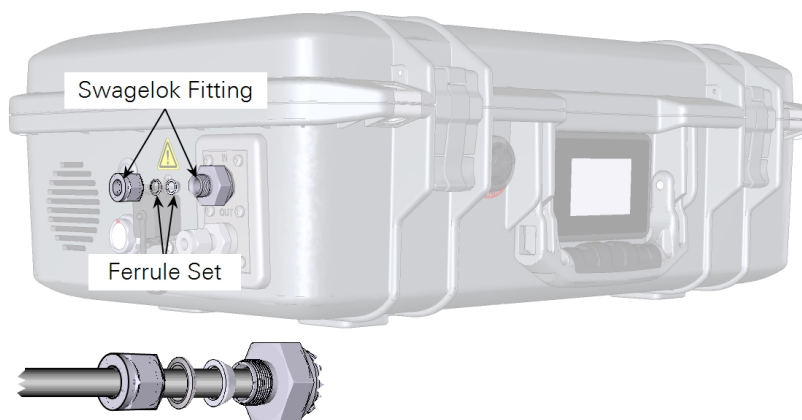

*Figure 3-2. When connecting a tube to the air inlet, use nylon ferrules with plastic tubing and steel ferrules with metal tubing.*

Tighten the nut over the ferrule set until it is finger tight. For metal and plastic tubing, tighten it an additional 1¼ turns if you are connecting the tube for the first time. If your plastic tube is highly pliable, you may need to use tube inserts for compression fittings to make the end of the tube more rigid. When reconnecting a plastic or metal tube that has been connected previously, simply tighten it ¼ turn beyond finger tight. Tubing can be connected to the outlet in the same way.

**Important:** Abrupt pressure transients up to 35 kPa above ambient pressure may cause the momentary status warnings and measurement inaccuracies. Longer lasting pressure excursions may cause the instrument to reinitialize measurement control loops. The instrument will always record the status associated with a data value. Under high pressures, the pressure relief valve may open temporarily until the pressure returns to an acceptable level. Pressures in excess of 110 kPa absolute pressure may damage the instrument.

## Plumbing a subsample

**Note:** We are currently refining numerous sampling protocols for the LI-7810. Contact LI-COR technical support ([envsupport@licor.com](mailto:envsupport@licor.com)) if you have questions about your application.

A typical sampling application will use the LI-7810 to subsample a gas from a main sample line. Air passes a single time through the gas analyzer before it is discharged. Air supplied to the sample inlet should be between ambient and 35 kPa (5 PSI) above ambient. If the pressure is higher than that, install a 30 cm vent in the sample line to ensure that air from the external pump does not pressurize the analyzer. The vent must be sufficiently long to prevent diffusion of ambient air into the sample air supply.

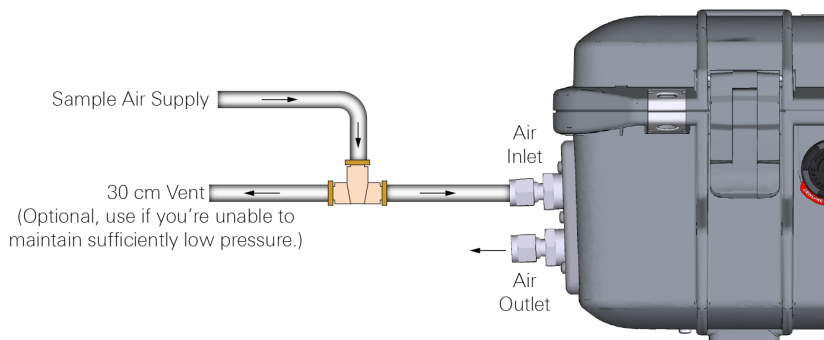

*Figure 3-3. A basic open system, where air is supplied to the gas analyzer by an external pump. If the pressure exceeds 35 kPa above ambient, install a 30 cm vent in the air supply line. Attach the inlet to the 'leg' of the T-fitting to avoid isotopic fractioning.*

## Retrieving data from the instrument

The LI-7810 records all of its data after it has warmed up. There is no way to turn data logging on or off because data are always logged. The instrument supports two protocols for transferring data: Direct download and MQTT (Message Queuing Telemetry Transport). Here we describe direct download. The other methods will be described in subsequent materials published to the technical support website ([licor.com/env/support](http://licor.com/env/support); search for `LI-7810 communication`).

### Downloading a data file

When you want to retrieve data from the instrument, click **Download** (📄) in the upper right of the window. Specify a date range and time period. Dates are displayed as YYYY-MM-DD. Time options are given in a 24-hour clock (00:00 through 24:00). Click **Export**. The web browser will prompt you to save or open the file, and then provide a text file with the requested data. The file has a `.data` extension. Measurements are recorded as tab-delimited text that can be opened in a text editor or spreadsheet application.

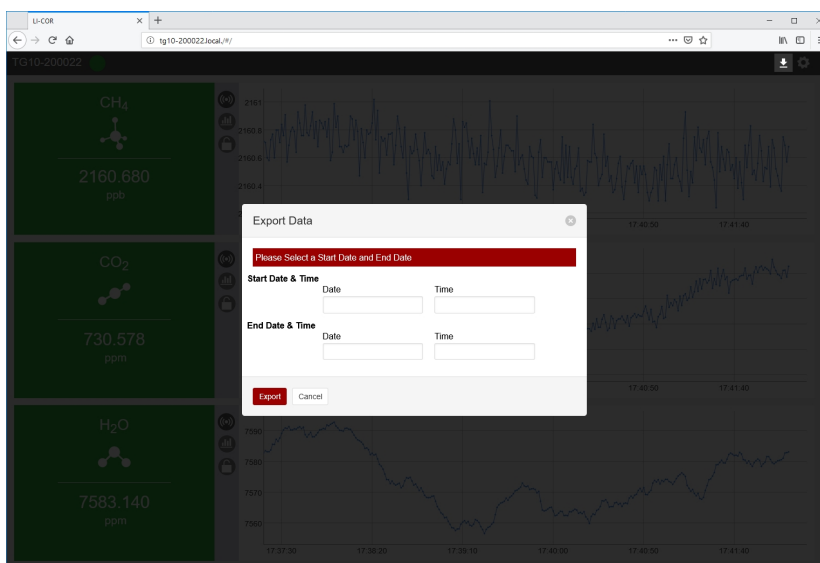

## Components of the data file

The text file will include a file header, data header, and data.

### File header

The file header provides information about the instrument that measured the data.

Header Label	Description
Model	The model of the instrument
SN	The serial number of the instrument
Software Version	The software version on the instrument
Timestamp	The date and time of the beginning of the requested data (according to the instrument clock; yyyy-mm-dd hh:mm:ss).
Timezone	The timezone setting on the instrument when the data is requested.

### Data header

The data header identifies the columns of values that are in the file. You'll see two rows: one called DATAH, which gives the variable names for the corresponding columns, and one called DATAU, which gives the units for the corresponding columns.

DATAH	DATAU	Description
SECONDS	secs	Seconds past the universal epoch (Unix time).
NANOSECONDS	nsecs	Nanoseconds of the seconds
NDX	index	A count of scans. At four scans per second, the value increases by four counts per second.
DIAG	diag	Diagnostic code (see <i>Status codes</i> on page 2-9)
DATE	date	Date of the record in yyyy-mm-dd
TIME	time	Time of the record in HH:MM:SS (according to the instrument clock)
H2O	ppm	Water vapor concentration
CO2	ppm	Carbon dioxide concentration
CH4	ppb	Methane concentration
CAVITY_P	kPa	Optical cavity pressure (typically near 39)
CAVITY_T	°C	Optical cavity temperature (typically near 55)
LASER_PHASE_P	kPa	Laser phase pressure
LASER_T	°C	Laser temperature
RESIDUAL	n/a	Difference between raw and best fit spectra

DATAH	DATAU	Description
RING_DOWN_TIME	µsecs	Indicator of cavity resonance
THERMAL_ENCLOSURE_T	°C	Optical enclosure temperature
PHASE_ERROR	counts	Dimensionless indicator of mode lock state
LASER_T_SHIFT	°C	Shift in laser center wavelength from factory calibration
INPUT_VOLTAGE	V	Power supply voltage
CHK	CHK	Checksum; to ensure that the receiving software received the data without error, and to reject corrupted data lines

### Time, data , and diagnostics

The time, data, and diagnostics are given under the header.

```

1 Model: LI-7810
2 SN: TG10-200022
3 Software Version: 1.3.58
4 Timestamp: 2018-12-18 03:00:00
5 Timezone: GMT
6 DATAH SECONDS NANOSECONDS NDX DIAG DATE TIME H2O CO2 CH4 CAVITY_P CAVITY_T LASER_PHASE_P LASER_T RESIDUAL R
7 DATAU secs nsecs index diag date time ppm ppm ppb kPa °C kPa °C µsecs °C counts °C V CHK
8 DATA 1545102000 133117914 191060 0 2018-12-18 03:00:00 7053.4 632.508 2121.39 39.7648 54.9987 33.6161 37.6443 0.001
9 DATA 1545102001 133117914 191064 0 2018-12-18 03:00:01 7054.37 631.9 2121.29 39.766 54.9987 33.6156 37.6441 0.001
10 DATA 1545102002 133117914 191068 0 2018-12-18 03:00:02 7053.35 632.699 2121.51 39.7619 54.9987 33.6161 37.6441 0.001
11 DATA 1545102003 133117914 191072 0 2018-12-18 03:00:03 7053.64 631.997 2121.49 39.7636 54.9987 33.6152 37.6441 0.001
12 DATA 1545102004 133117914 191076 0 2018-12-18 03:00:04 7052.58 632.973 2121.39 39.764 54.9987 33.6165 37.6441 0.001
13 DATA 1545102005 133117914 191080 0 2018-12-18 03:00:05 7052.86 632.687 2121.43 39.7623 54.9987 33.614 37.6443 0.001
14 DATA 1545102006 133069038 191084 0 2018-12-18 03:00:06 7052.3 632.26 2121.49 39.7652 54.9987 33.614 37.6443 0.001
15 DATA 1545102007 133069038 191088 0 2018-12-18 03:00:07 7051.49 632.693 2121.71 39.7673 54.9987 33.6156 37.6441 0.001
16 DATA 1545102008 133069038 191092 0 2018-12-18 03:00:08 7051.37 632.589 2121.62 39.7648 54.9987 33.6173 37.6445 0.001
17 DATA 1545102009 133069038 191096 0 2018-12-18 03:00:09 7051.47 631.931 2121.19 39.7619 54.9987 33.6156 37.6443 0.001
18 DATA 1545102010 133069038 191100 0 2018-12-18 03:00:10 7052.4 632.41 2121.31 39.7623 54.9987 33.6161 37.6445 0.001
19 DATA 1545102011 133069038 191104 0 2018-12-18 03:00:11 7053.99 632.09 2121.88 39.7652 54.9987 33.6148 37.6441 0.001
20 DATA 1545102012 133069038 191108 0 2018-12-18 03:00:12 7054.23 632.111 2121.78 39.7644 54.9987 33.6173 37.6447 0.001
21 DATA 1545102013 133069038 191112 0 2018-12-18 03:00:13 7055.27 631.956 2121.74 39.7654 54.9987 33.6156 37.6441 0.001

```

### The relationship between Unix Epoch time and the time stamp

The instrument measures time based upon the number of seconds past the Unix epoch (GMT: Thursday, January 1, 1970 12:00:00 AM). This value is represented in the **Seconds** column of the data set. You can easily convert the Unix epoch to date and time using online resources (e.g., <https://www.epochconverter.com>). If you have selected a time zone, the Date and Time columns will represent the Unix epoch time adjusted by an offset for the time zone.

## Installing the instrument in a rack mount

The LI-7810 can be mounted in an instrument rack with a stationary or sliding shelf with dimensions of at least 33 cm by 61 cm (13" by 24") with 18 cm (7") of vertical clearance. The instrument dimensions are given in *Figure C-1* on page C-2. Be sure that the vents on the sides are not obstructed. Allow 2 to 3 cm (~1 inch) of clearance on either side of the vents. Ensure that air flow can move freely around the case.

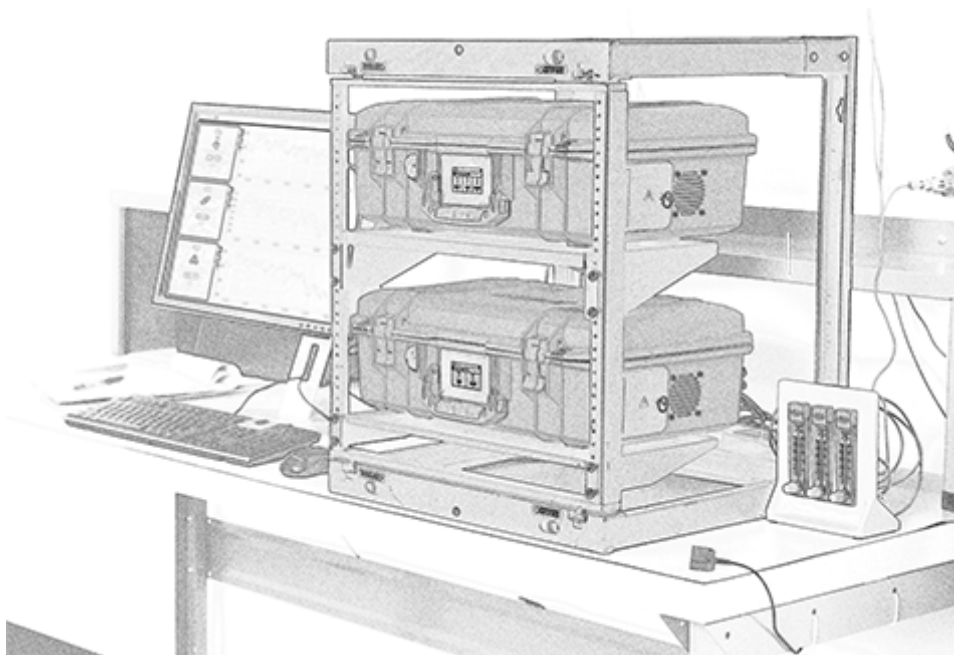





# Section 4.

## Software overview

---

The web interface provides access to the most important settings in the gas analyzer. Here, you can view graphs of data, download recorded data, configure the display, and alter instrument settings.

### Home page

When you first connect to the instrument, it will display a home page with measurements, graphs, and options. You'll see the instrument serial number and status in the upper left. Normal operation is indicated by a green dot. A warmup or other status is indicated by an exclamation point in a yellow or red dot beside the instrument name. You can click and drag to zoom in on the graphs and reset the zoom by double-clicking the graph.

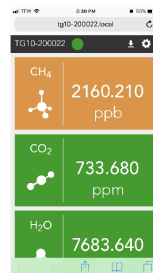
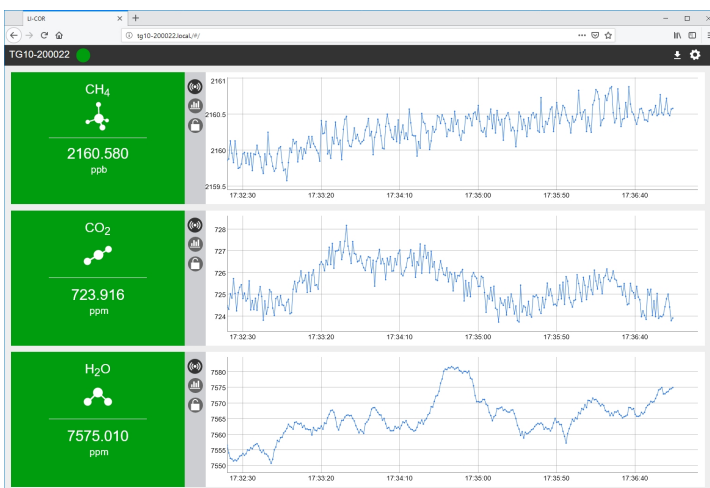



Click to display the entire history of measurements of this variable.



Click to hide or show anomaly stripes (to indicate when a measured value exceeds a threshold; see *Thresholds* on page 4-4).



Click to lock the graph to the current view. Click again to restore live graphing.



Click to return to the home page (only visible when not on the home page).



Click to export data (see *Downloading a data file* on page 3-4).



Click to view the settings menu.

For any gas, you can click the rectangular panel to view more details, including the current measurement, mean, standard deviation, and slope for the displayed time range. You can adjust the plotted time range with a slider or by typing in the number of seconds in **Graph Range (Seconds)**. Click **Reset** to restore the default range of 300 seconds.

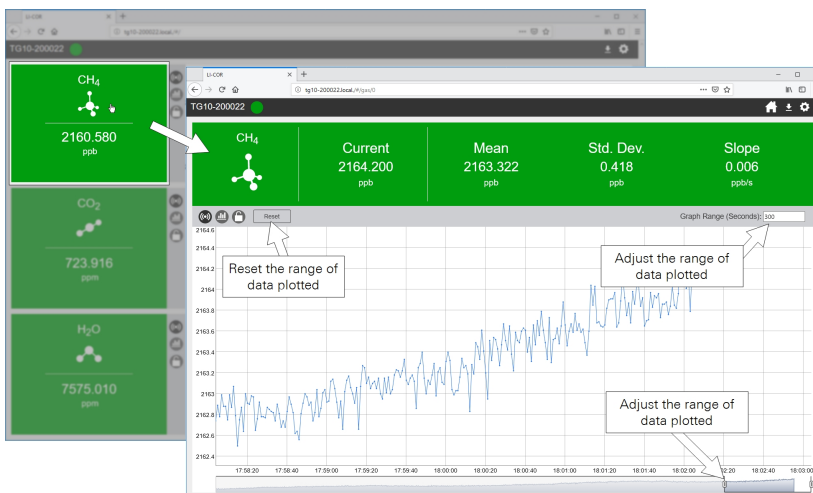

# Layouts

You can customize the graphical layout. If, for example, you are only interested in viewing  $\text{CH}_4$  and  $\text{CO}_2$  measurements, you can select a layout that displays two gases and then select the two gases of interest.

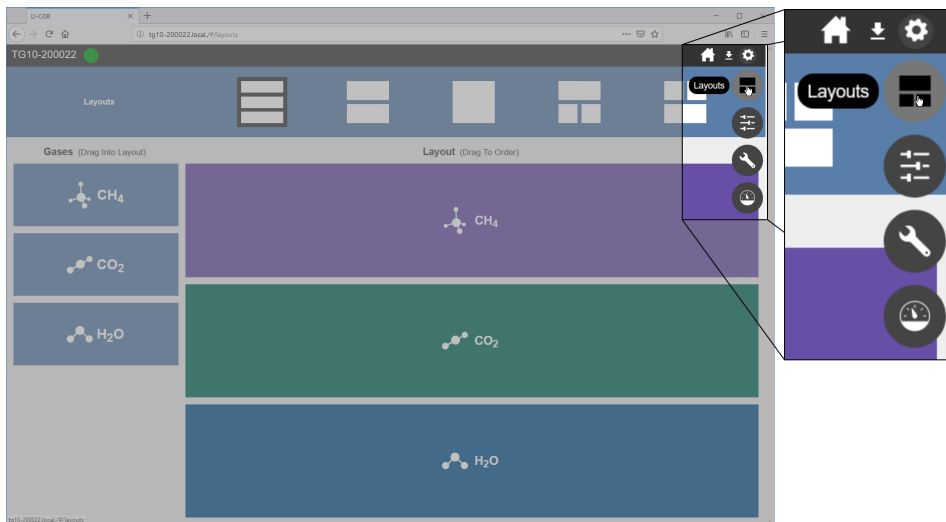

# Thresholds

The software provides simple, configurable indicators of whether the measured gas concentration exceeds or drops below a threshold. It provides color-coded indicators when the measured gas is within or outside of the specified range. When you have set a **Low Threshold** or **High Threshold** for a gas, the home page will indicate if the measurement is outside of the threshold on the graph with anomaly stripes (click **Hide/Show Anomaly Stripes**; ) and the status by color coding the reported values. You can change the colors by clicking **Low Color**, **Middle Color**, or **High Color** on the Thresholds page. Thresholds are for display only; they are not recorded in the data file.

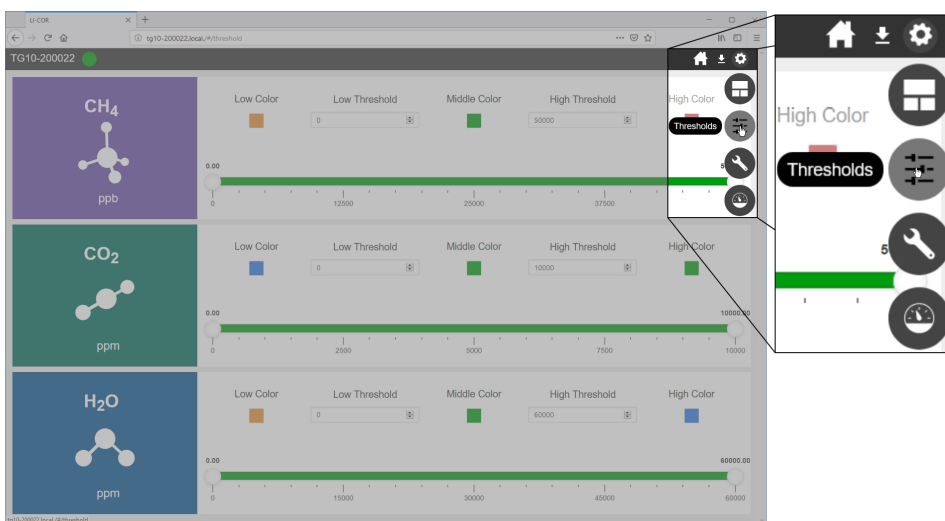

# Network

Network is where you configure the basic instrument settings, including time, networking, and wireless networking. These are described below.

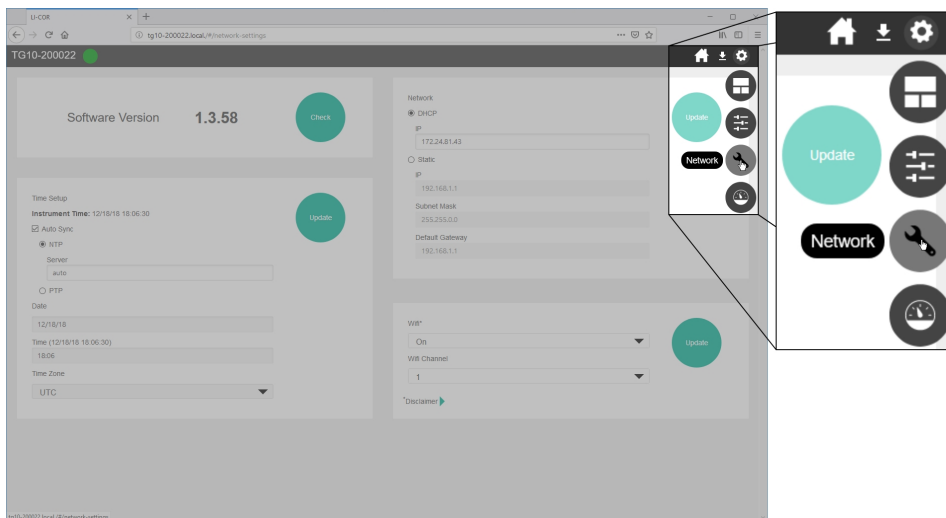

## Software Version

This indicates the software version running on the instrument. Click **Check** to check for software updates. The instrument must be online to check.

## Time Setup

Here you specify how the instrument sets its time. If you change the settings, click **Update** to apply them.

**Auto Sync:** We recommend using this setting at all times to prevent clock drift. When selected, the instrument will set its clock according to the local network time. When not selected, you must enter the desired time manually. The Auto Sync options are:

- **NTP:** Network Time Protocol. A time protocol designed for low-cost time synchronization between computers and devices. You can use the default settings of **auto** or select an NTP server, either from your network or the internet. A list of NIST time servers is available from <https://tf.nist.gov/tf-cgi/servers.cgi>.

- **PTP:** Precision Time Protocol. A network time protocol designed for high accuracy (microsecond to nanosecond) time synchronization between clocks.

**Date:** If Auto Sync is cleared, you can enter a date manually.

**Time:** If Auto Sync is cleared, you can enter the time manually.

**Time Zone:** You can select a time zone that applies an offset to the Unix epoch time.

When the instrument time setting is set to **Auto Sync** and the instrument is connected to the internet, it will maintain very accurate time, in sync with NTP or PTP clocks. If Auto Sync is disabled, or the instrument is not online, expect the clock to drift up to several seconds per month, or more.

## Network

This is where you configure the network settings. If you change the settings, click **Update** to apply them.

**DHCP:** Dynamic Host Configuration Protocol; This setting is suitable for most networks. When selected, the network assigns an IP address to the instrument.

- **IP:** The assigned IP address is displayed here (and on the instrument display).

**Static:** Used to set a static IP address. This setting is used when configuring the instrument to communicate over a cellular gateway, such as the Sierra Wireless RV-50 AirLink. When selected, you manage the networking manually by setting the IP address, subnet mask, and possibly the gateway.

- **IP:** Enter the desired IP address. For a local network, you'll use something like 172.24.1.nn, where the values represented by nn are octets that uniquely identify this instrument on the network.
- **Subnet Mask:** Typically 255.255.255.0.
- **Default Gateway:** Set the first two octets to match those of the IP address.

## Wi-Fi

Here you can configure the wireless network settings, including whether the wireless network is on or off, and which channel it uses. You can always use the default setting, but if there are many devices using that channel, you may have better results with a channel that has fewer devices. If you have difficulty connecting, try changing the channel that the instrument uses.

When Wi-Fi is on, the instrument will create a local network that is not connected to the global internet. You should see the network on the list of available networks. The network name is the same as the instrument serial number. If you change the settings, click **Update** to apply them. You can also choose a channel for communication over the wireless network. When there are many Wi-Fi networks available in one location, you can assign a specific channel for a more reliable connection.

**Note:** This product is capable of creating a Wireless Local Area Network (WLAN). The use of WLAN is restricted in some regions and countries. The illegal use of WLAN may be punishable under these regulations. Check your local regulations to determine if WLAN is permitted. LI-COR, Inc. cannot be held liable for any problems arising from the use of WLAN in any countries or regions. Legal penalties may result from any of the following:

- Enabling a wireless network where it is not permitted
- Modifying or altering the product
- Removing the certification labels from the product

# Settings

The performance monitor provides instrument performance information, including the status, warnings, and diagnostic information.

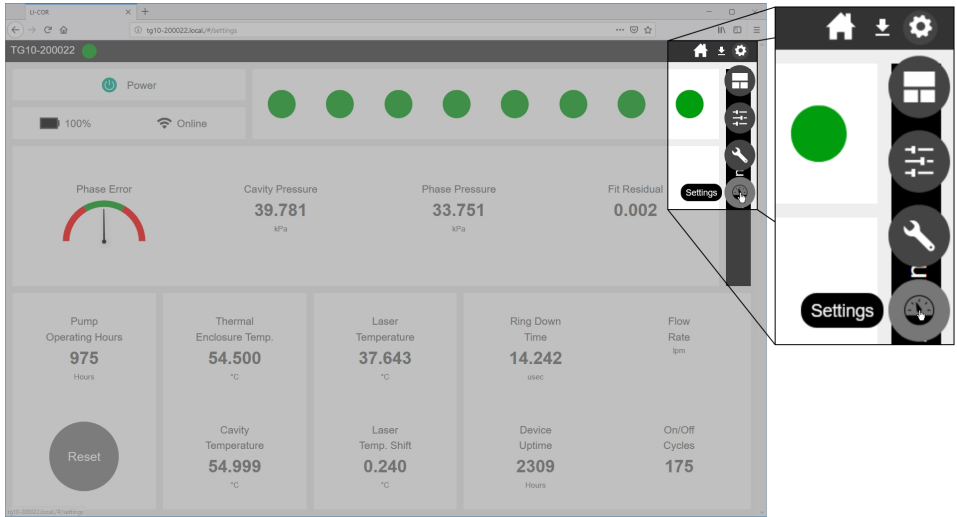

## Power

In the upper left, the **Power** option allows you to power off or restart the instrument. The instrument cannot be powered on remotely.

## Battery Status

The battery charge status and level is indicated.

## Network Status

Indicates whether the wireless network is on or connected.

## Performance status indicators

In the upper right, a series of eight bubbles provides more detailed status information. Normal operation is indicated by green bubbles. An exclamation point indicates that the instrument is not in a normal operating state. Typically these are displayed when the instrument is warming up, and the status message will



disappear when the warmup is completed. Click a bubble to view the status. See *Status codes* on page 2-9 for more information.

## Performance monitor

The lower portion of the window provides more details about the instrument performance.

**Phase Error** is an indicator of the symmetry of cavity modes. During normal operation the needle will be within the green part of the dial.

**Cavity Pressure** is measured in the optical cavity. The instrument operates around 40 kPa typically. If the values are colored red, that indicates that the instrument is unable to regulate the cavity pressure. Normally this value is within 1 kPa of the setpoint.

**Phase Pressure** refers to the pressure for the phase adjuster volume. If red, the instrument is unable to regulate the pressure to get optimal phase adjustment. Normally this value is within 1 kPa of phase pressure setpoint.

**Fit Residual** is the difference between the raw spectra and the best fit spectra which generates the measured concentrations. If the residual is red, it indicates that the instrument is unable to process the data properly and that the concentrations are not being reported accurately. Data will be flagged in this case.

**Pump Operating Hours** is the number of hours that the pump has operated.

**Thermal Enclosure Temp** is the temperature of components inside the foam insulating enclosure. If red, the instrument is either too hot and unable to regulate the enclosure temperature, or too cold and in a warmup state. Normally this is between 51.5 °C and 57.5 °C.

**Cavity Temperature** is the optical bench temperature. If red, the instrument is either too hot and unable to regulate the cavity temperature, or too cold and in a warmup state. Normally this is between 52 °C and 58 °C.

**Laser Temperature** is the temperature of the diode laser. If red, the instrument is unable to regulate the laser temperature.

**Laser Temp. Shift** is the shift in the laser center wavelength from the factory calibration.

**Ring Down Time** is a parameter indicating cavity resonance.

**Device Uptime** shows the number of hours that the instrument has been powered on.

**Flow Rate** in instruments that are equipped with a flow meter, this value is the rate that gas is moving through the gas analyzer. If red, the flow rate is too low. Normally this is between 0.2 to 0.32 lpm. This value is blank if there is no flow meter.

**On/Off cycles** is the number of times the instrument has been powered on.

If your instrument is displaying warnings that do not resolve themselves over the course of a few hours or by restarting, contact technical support.

## Advanced

The **Language** setting is configured under settings. Click **Advanced** to change the language settings. The interface can be displayed in English, Spanish, and simplified Chinese languages. The language setting is retained in the web browser, not the instrument. If you connect with a different browser or different computer, or if you clear your browser cache, the default language setting will be applied (English).

**CH4 Span** is to set the instrument span calibration. Do not change the settings unless you are certain that your actions will improve the performance of the instrument.

**Restore Span/Zero** allows you select a previous zero and span setting.

**Download Diagnostic Log** is to download a dataset that includes detailed performance information. This option should be used in consultation with LI-COR technical support in order to resolve performance issues. Diagnostic log files can be very large, (hundreds of MB, depending on the time and date range), so we recommend that you constrain the dates to a narrow time window when downloading a diagnostic log.

**Last Zero/Span** gives the date of the most recent zero or span calibration. See *Instrument calibration* on page 6-1

**Factory Reset** Use this if the calibration gets incorrigibly messed up. This reloads the factory original zero and span calibration parameters.

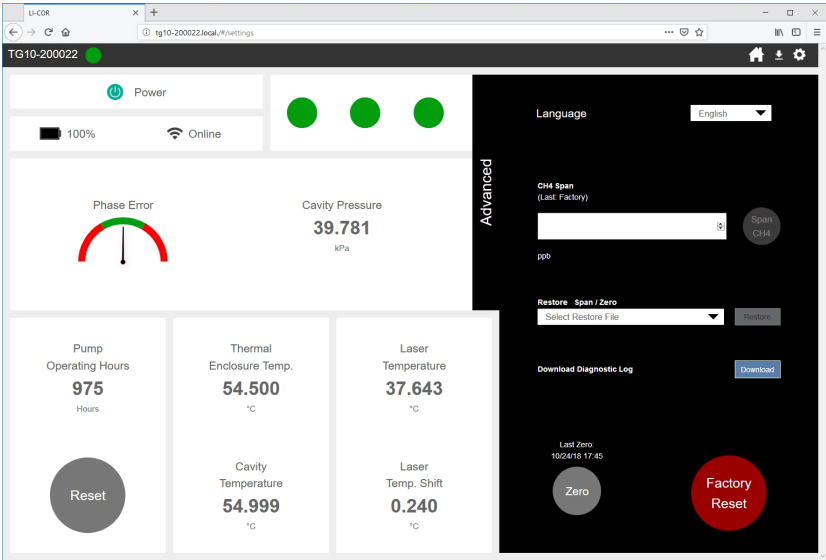



# Section 5.

## Troubleshooting

---

Here we describe common issues and solutions. If things aren't working as you expect, start here.

### Unable to connect with the instrument over a wired connection

Network cable disconnected? Check both ends to be sure it is connected to the instrument and to your computer or network.

Instrument on a different network than PC? If you are using an Ethernet cable, be sure the instrument network cable and your PC network cable are connected to the same local network.

Network not detected by the instrument? Check the IP address given on the instrument display. If the display says IP:down, the instrument is not detecting a suitable network (the network cable may be unplugged, network switch or routers may be powered off, the IP address setting in the instrument may be incompatible with the network or computer).

IP address setting incompatible with the network settings? If the instrument IP address or your computer's IP address is set to static, you may need to alter either your computer or instrument network configuration. To restore connectivity, make the computer IP address compatible with the instrument IP address. This procedure may work on Windows 10:

- 1 Press the Windows key () , type `cmd`, and press **Enter** to open the command prompt.
- 2 Type `ipconfig` and press **Enter**.
- 3 Your computer will reply with its network configuration information. You're interested in the IPv4 Address.

- 4 Compare your computer's IP address with the instrument's IP address given on the display. If the IP addresses are not compatible (see *Table 5-1* below), you will not be able to connect until you have changed one or both IP addresses.

**Table 5-1.** Incompatible IP addresses that will lead to connection issues.

Component	IP Address	Issue	Potential Solution
LI-7810	172.24.1.1	Same IP address (the last set of octets must be different)	Change PC IP address to 172.24.1.2
PC	172.24.1.1		
Component	IP Address	Issue	Potential Solution
LI-7810	172.24.1.1	Different network (the first two or three octets must be the same)	Change PC IP address to 172.24.1.2
PC	192.168.1.1		

To change your computer's IP address (Windows 10):

- 1 Press the Windows key () , type **IP Address**, and press **Enter**.
- 2 In the window that opens, click **Change adapter options**.
- 3 In the window that opens, double click the icon that represents your network connection, and then click **Properties**.
- 4 Double click **Internet Protocol Version 4 (TCP/IP)** to open the IPv4 Window.
- 5 In the window that opens, select **Use the following IP address** and enter an IP address that is compatible with the instrument IP address. The first three octets will be the same as the instrument IP address, but the final set of octets must be different.

Instrument	Compatible IP Addresses
LI-7810	172.24.1.1
PC	172.24.1.2 through 172.24.1.255
Instrument	Compatible IP Addresses
LI-7810	192.168.1.1
PC	192.168.1.2 through 192.168.1.255

- 6 Connect with the instrument by entering the host name in a web browser address bar.
- 7 Now you can change the instrument IP address settings to whatever you prefer. Connection issues will be resolved if you set both the instrument and your computer to **automatic**.

**Note:** You must reconnect after changing the instrument IP address.

## Unable to connect with the instrument over a wireless connection

**Note:** This product is capable of creating a Wireless Local Area Network (WLAN). The use of WLAN is restricted in some regions and countries. The illegal use of WLAN may be punishable under these regulations. Check your local regulations to determine if WLAN is permitted. LI-COR, Inc. cannot be held liable for any problems arising from the use of WLAN in any countries or regions. Legal penalties may result from any of the following:

- Enabling a wireless network where it is not permitted
- Modifying or altering the product
- Removing the certification labels from the product

Try again a few times. The issue could be related to transient heavy network traffic. Some network channels may be transmitting a lot of data (like videos, for example), causing communication to time out.

Wireless networking turned off? If you are attempting to connect over wireless, be sure it is enabled in the software. The display will show a wireless network symbol (📶) when enabled. If wireless networking needs to be enabled, connect with a wired network connection and enable it as described in *Wi-Fi* on page 4-6.

Computer or mobile device connected to the instrument network? If using wireless, be sure you have connected your PC to the instrument's Wi-Fi network before connecting in the web browser.

Too many devices in a confined space? We have experienced wireless connection issues when several wireless devices are close together. Move your instrument to a different room or another place where there are fewer wireless devices.

Wireless antenna unplugged? The wireless antenna is adhered to the internal plastic electronics shroud. It has a very small connector that plugs into the circuit board. Power off the instrument, remove the cover screws, and lift the cover slightly to see if the antenna is attached to the connector on the circuit board (see *Figure B-3* on page B-5). The connector is near the lower left corner of the processor. If is unplugged from the circuit board, reattach it and try to connect again.

## The interface is in a language that I don't understand

The interface can be displayed in English, Spanish, and Simplified Chinese. If you need to change the language setting, click the gear, and then click the dial for settings. Click the **Advanced** tab (Avanzado; 高级设置) to access the language selector. The language setting is stored in the web browser. Any time you connect with a browser for the first time or clear your browser cache, the language setting will be in the default state (English).

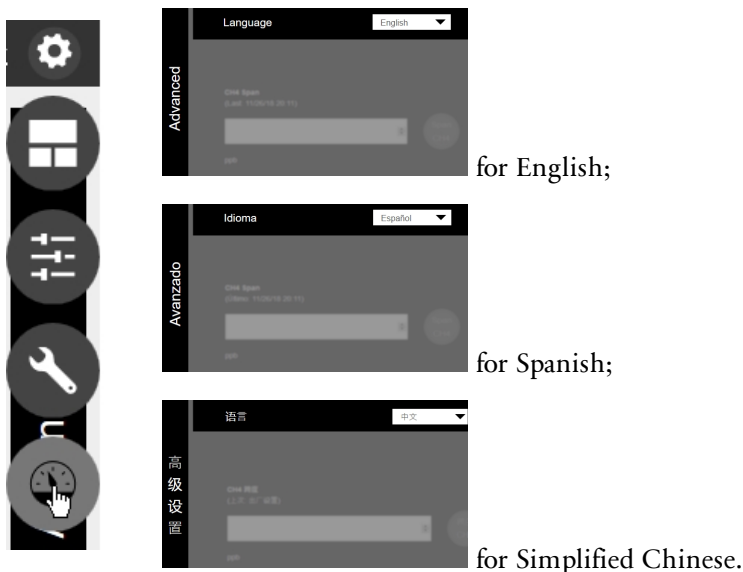

## Readings drift or step change unexpectedly

Constricted inlet or outlet? If one of these becomes constricted, you will observe errant measurements, with corresponding status codes that indicate problematic pressure measurements (see *Status codes* on page 2-9). Clear the constriction and the instrument should return to normal operation in a few minutes. Restart the instrument if it does not resume normal operation within a few minutes.

## Graphed data overlaps in time or has gaps

If you have been altering the time and time zone settings, the browser may receive overlapping time information. Refresh your web browser to reload the display. The issue should be resolved. Data are always logged with the Unix time.



## Pressure readings are questionable or unstable

Clogged air inlet filter? Check and replace the filter if needed, as described in *Replacing the air inlet filter* on page 6-4. Otherwise, unstable pressure readings may indicate that the pump is failing. Contact technical support if the issue is not resolved by replacing the filter.



## Section 6.

# Maintenance

---

The LI-7810 will require little maintenance. There are no user-serviceable parts in the instrument except for the air inlet filter, air dry-down chemical, pump, and optional flow meter. Do not attempt to disassemble the instrument or conduct any maintenance procedures other than those described here.

## Instrument calibration

To adjust the linearity of the instrument calibration, you can set the zero and span. The span is like a slope (the  $m$  in  $y = mx + b$ ). The zero is an spectral baseline. Adjusting the zero changes every measurement (the relationship is non-linear). Adjusting the span changes the slope and affects measurements of higher concentrations more than it affects low concentrations. Calibration gases should be at a pressure between ambient and 35 kPa (5 PSI) above ambient pressure. If you are unable to reduce the pressure to that range, we recommend installing a >30 cm vent before the air inlet to vent the excess pressure and prevent diffusion of ambient air into the gas stream.

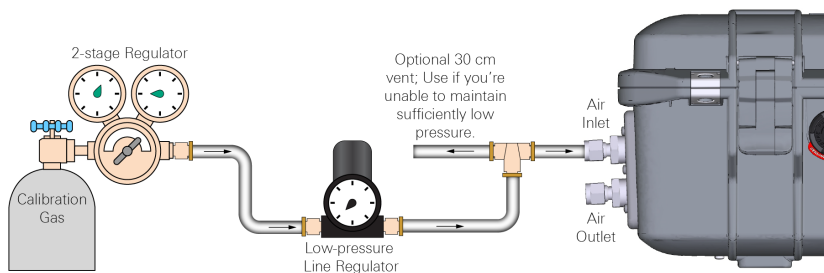

*Figure 6-1. Plumbing configuration for calibration gases. A low pressure regulator or 30 cm vent may be required if the tank regulator is unable to provide sufficiently low pressure.*

## Setting the zero

Select a quality zero gas. The gas should be 0 ppm methane in air; the calibration will only be as good as the gas. It will take up to 5 minutes for the instrument to adjust the zero.

**Caution:** Do not use nitrogen-balanced gas. Use air-balanced gas for both the zero and span. Do not power on the instrument with a 0 ppm methane gas flowing through the analyzer or the analyzer will not initialize properly.

- 1 Power on the instrument and let it warm up.
- 2 Plumb a gas to the air inlet as shown in *Figure 6-1* on the previous page.  
Set the pressure between ambient and 35 kPa (5 PSI) above ambient.  
Observe the measurements on the home screen until they have stabilized. The standard deviation and slope will be near zero.
- 3 Zero the analyzer.  
Under **Settings > Advanced**, click **Zero**. The software will indicate that a zero calibration has started and it will not report concentrations until the zero is set. This usually takes about 5 minutes.

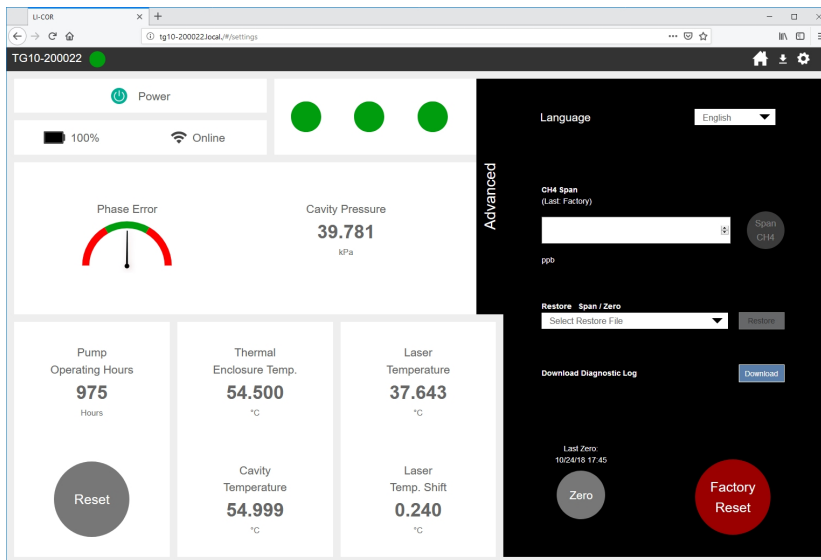

## Setting the span

Select a quality span gas with a methane concentration near the concentrations you expect to measure.

**Caution:** Do not use nitrogen-balanced gas. Use air-balanced gas for both the zero and span.

- 1 Power on the instrument and let it warm up.
- 2 Plumb a gas to the air inlet as shown in *Figure 6-1* on page 6-1.  
Set the pressure between ambient and 35 kPa (5 PSI) above ambient.  
Observe the measurements on the home screen until they have stabilized. The standard deviation and slope will be near zero.
- 3 Span the analyzer.  
Under **Settings > Advanced**, enter the concentration of the gas and click **Span**.

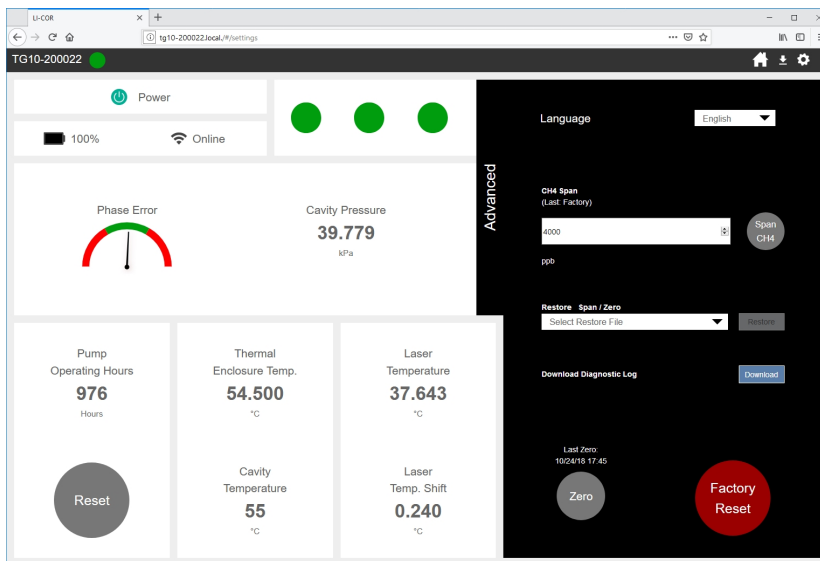

## Recovering from a bad calibration

In the event that an attempt to zero or span fails to work as intended, you can restore previous zero and span settings by selecting the file and clicking **Restore**.

## Replacing the air inlet filter

The air intake has a filter that may become contaminated periodically. We recommend replacing it every year, or more often if you are sampling dirty or dusty air.

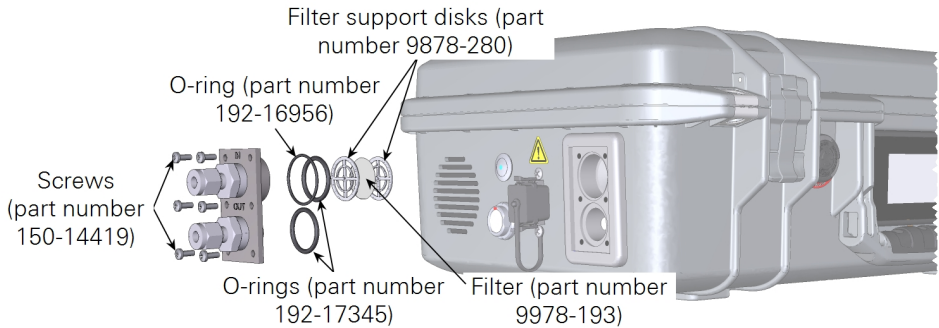

- 1** Power off the instrument.
- 2** Remove each of the six screws that secure the air intake and outlet.  
They are installed with thread locking compound, which will make them difficult to remove.
- 3** Remove the O-rings, the filter support disks, and the filter.  
Use a toothpick to work them out.
- 4** Inspect the O-rings and replace them if they are damaged or compressed.
- 5** Install the replacement filter and reassemble the system.  
Two metal discs support the filter — one on each side. Assembly is the reverse of disassembly. You do not need to use thread locking compound on the threads. Tighten them snugly.

## Replacing the purge dry-down chemical

The purge chemical, consisting of silica gel beads, is contained in a non-porous tube. The instrument will pump air through the purge tube during the power-off routine to ensure that the optics are free of water vapor while the instrument is in storage. You may need to replace the chemical periodically. The silica gel pellets are orange when new and green when saturated.

**Warning:** *May cause irritation. MAY CAUSE SKIN IRRITATION. MAY CAUSE RESPIRATORY TRACT IRRITATION. MAY CAUSE PAIN, NAUSEA, VOMITING AND DIARRHEA. May result in coughing and/or sore throat. PROLONGED OR REPEATED EXPOSURE TO DUST MAY CAUSE PULMONARY PROBLEMS. INGESTION MAY CAUSE GASTRIC DISTURBANCES.*

**Advertissment:** *Peut causer une irritation. PEUT CAUSER UNE IRRITATION DE LA PEAU. PEUT CAUSER UNE IRRITATION DE LA VOIE RESPIRATOIRE. PEUT CAUSER DOULEURS, NAUSÉE, VOMISSEMENTS ET DIARRHÉE. Peut entraîner une toux et / ou un mal de gorge. L'EXPOSITION PROLONGÉE OU RÉPÉTÉE A LA POUSSIÈRE PEUT CAUSER DES PROBLÈMES PULMONAIRES. L'INGESTION PEUT CAUSER DES PERTURBATIONS GASTRIQUES.*

To replace the purge chemical:

- 1 Power off the instrument.
- 2 Open the lid and locate the purge chemical column.
- 3 Disconnect the quick-connect fittings from the column inlet and outlet.

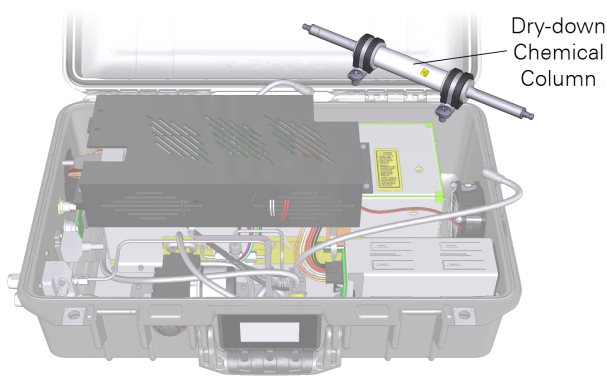

**4** Remove the column.

It is secured with two screws. Remove them. When the column mounting brackets are removed, the column can come apart easily, and the silica gel beads can fall out. Be careful when handling the column so that it does not come apart.

**5** HOLDING THE COLUMN AWAY FROM THE CASE, separate one end by grasping one cap and pulling it off of the column.

Pour out the silica gel beads. They can be disposed of in municipal waste.

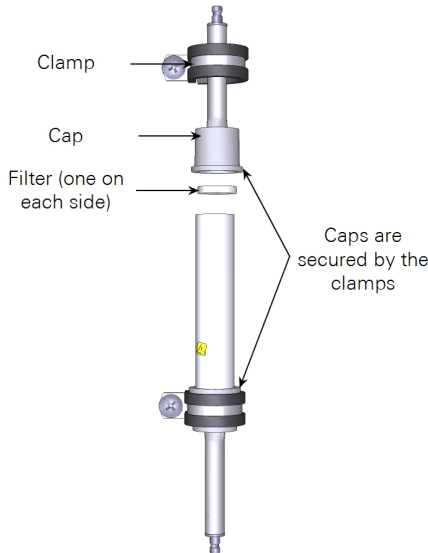

**6** Locate a new packet of silica gel beads in the accessories kit.

**7** Fill the column with fresh silica gel beads.

There may be a little more than is needed. Dispose of the extra silica gel beads.

**8** Reassemble the filter and caps; connect the tubes, and tighten the screw clamps securely.

**Important:** Tighten the clamp screws securely. The clamps hold the caps onto the tube; the caps hold the silica gel beads in the tube. If the clamps are not tight, the caps will be forced off when the tube is pressurized during shutdown. The tube will open and the silica gel beads will spill in the case. It is a situation easily avoided by tightening the clamp screws securely.



## Appendix A.

# Measurement overview

---

To measure gases, the analyzer injects laser light into a V-shaped optical cavity defined by mirrors 1, 2, and 3 (Figure A-1 below). The mirrors are highly reflective — photons may circulate many times before escaping to strike the sample photodiode. This long effective path-length enhances sensitivity by creating many opportunities for the sample gas flowing through the cavity to absorb light.

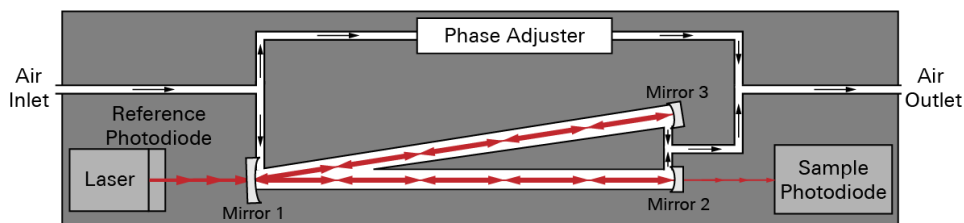

*Figure A-1. Simplified schematic of the LI-7810 flow path through the optical bench. The phase adjuster is a volume in the path between the laser and optical bench that is tied to a pressure control mechanism. Changing the pressure of that volume alters the refractive index which subsequently modifies the phase of the laser.*

The instrument ramps the laser drive current so the laser scans a range of wavelengths that span absorption features of the gases. A fraction of the photons are allowed to leak from the cavity back into the laser, creating optical feedback that narrows the laser output. This, in turn, couples a large fraction of the laser power to the cavity and locks the laser frequency precisely to the center of a cavity resonance mode.

During a scan, the instrument creates a dense grid of fixed cavity resonance modes that are equally spaced within a few kHz. The laser jumps discretely from one cavity resonance mode to the next.

To measure all three gases, the laser frequency scans across the full spectral range of interest in about 0.25 seconds (see *Figure A-2* below). It uses the reliably fixed grid spacing in combination with spectroscopic data to determine the exact frequency of each mode. The instrument uses two ring down events—one at the beginning and one at the end of a scan—to normalize the measured signal.

Absorption is computed at each resonance mode by comparing the normalized sample photodiode signal with the reference photodiode signal. The concentration of each gas is then determined by using a fitting algorithm that compares the measured absorption spectrum with internally stored high resolution spectrum.

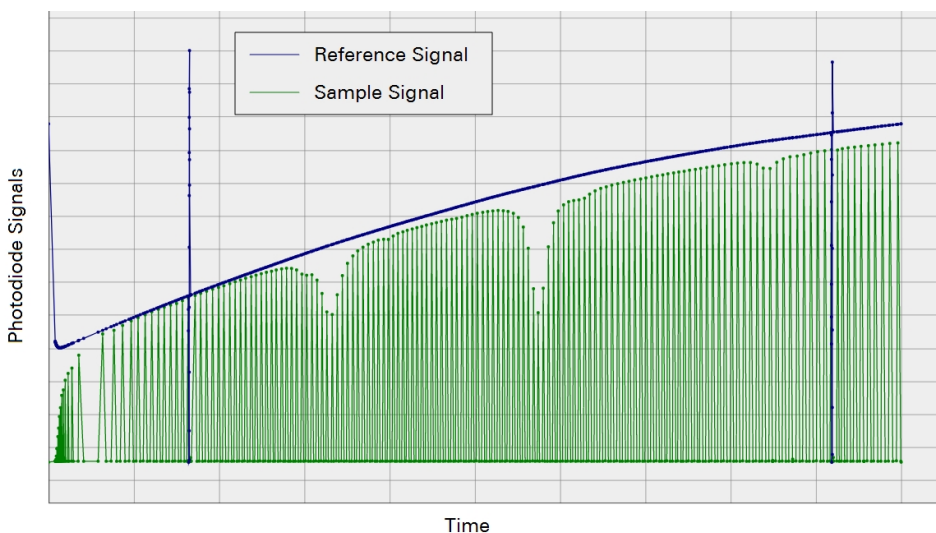

*Figure A-2. Example of a scan showing the absorption features for the three gases. The upper line (dark blue) is the reference signal, and the lower line (green) is the sample signal at each of cavity resonance modes.*

# Appendix B.

## Additional safety information

---

This section provides information about the safe use of the instrument, wireless channels, and disposal of batteries.

### Laser safety labels

The instrument has two laser safety labels: one inside the case and one on the back of the case.



**Warning:** *The use of controls, adjustments, or the performance of procedures other than those specified herein may result in hazardous radiation exposure.*

**Advertissment:** *L'utilisation des contrôles, d'ajustements, ou l'exécution des procédures autres que celles spécifiées ici peuvent entraîner une exposition dangereuse aux radiations.*

---

The LI-7810 is certified as a Class I laser product. No hazardous radiation is emitted from the instrument. Any laser radiation emitted is below the Class I laser limits during all phases of user operation. The laser emits (internally only) at approximately 1651 nm and has a Class 1M peak power rating of up to 75 milliwatts but is permanently set to <15 mW. This instrument complies with the CDRH regulations for laser products (CDRH radiation performance standard 21, Code of Federal Regulations Chapter 1, Subchapter J). Compliance for products marketed in the United States is mandatory.



Figure B-1. The Class 1 laser safety label is affixed to the back of the case.

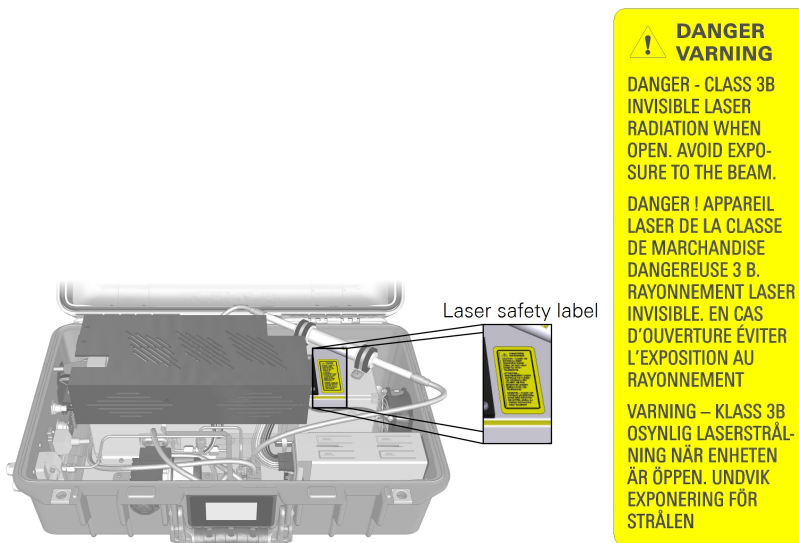

Figure B-2. The laser radiation safety label is inside the instrument case.

## Wireless communication notice

The instrument is equipped with wireless communication (Wi-Fi™) capabilities. Wi-Fi communication conforms to the requirements in this section. See *Getting Started* on page 2-1 for more details.

**Note:** This product is capable of creating a Wireless Local Area Network (WLAN). The use of WLAN is restricted in some regions and countries. The illegal use of WLAN may be punishable under these regulations. Check your local regulations to determine if WLAN is permitted. LI-COR, Inc. cannot be held liable for any problems arising from the use of WLAN in any countries or regions. Legal penalties may result from any of the following:

- Enabling a wireless network where it is not permitted
- Modifying or altering the product
- Removing the certification labels from the product

Channel Number	Lower Frequency (mHz)	Center Frequency (mHz)	Upper Frequency (mHz)
1	2401	2412	2423
2	2406	2417	2428
3	2411	2422	2433
4	2416	2427	2438
5	2421	2432	2443
6	2426	2437	2448
7	2431	2442	2453
8	2436	2447	2458
9	2441	2452	2463
10	2446	2457	2468
11	2451	2462	2473

Radio transmission power is given in *Table B-1* below.

**Table B-1.** Radio transmission power.

Network Type	Transmission Power
802.11b	10.5 dBm
802.11g/n	11 dBm

## Battery warnings and disposal



The instrument includes rechargeable lithium ion batteries and CR lithium batteries, which must be disposed of safely. The primary batteries are accessible through the battery cover on the case. The coin-cell batteries are in the case under an electronics shroud.

**Warning:** *Lithium ion batteries may cause environmental damage or damage to human health if they are disposed of improperly. Do not dispose of the batteries in unsorted municipal waste or an incinerator. Many localities have battery recycling facilities that will accept lithium ion batteries. Check your local regulations to determine how to safely dispose of the batteries.*

**Advertissment:** *Les batteries lithium ion peuvent causer des dommages à l'environnement ou endommager la santé humaine si l'on se débarrasse d'elles de manière inappropriée. Ne vous débarrassez pas des batteries dans des déchets municipaux non triés ou dans un incinérateur. Plusieurs localités ont des installations de recyclage de batteries qui accepteront les batteries lithium ion. Vérifiez vos réglementations locales pour déterminer comment se débarrasser des batteries en toute sécurité.*

### Primary batteries

To remove the primary batteries, turn the clasp counter-clockwise  $\frac{1}{4}$  turn to open the battery door. Grasp the tab on the battery and pull to remove the battery. There is space for two batteries. Be sure to remove both of them.



## Coin-cell battery

The product includes a CR Lithium coin-cell battery, which contains perchlorate material. Special handling may apply. In the U.S. State of California, see [www.dtsc.ca.gov/hazardouswaste/perchlorate](http://www.dtsc.ca.gov/hazardouswaste/perchlorate).

To remove the coin-cell batteries, power off the instrument, remove the batteries, and open the lid to the case. Remove the four screws that secure the electronics shroud. Being careful to avoid straining the Wi-Fi antenna (it is glued to the shroud), move the shroud to the side. The battery is near the middle of the instrument. The battery is held in with friction. Press it out. Insert a replacement battery with the positive (+) pole facing up.

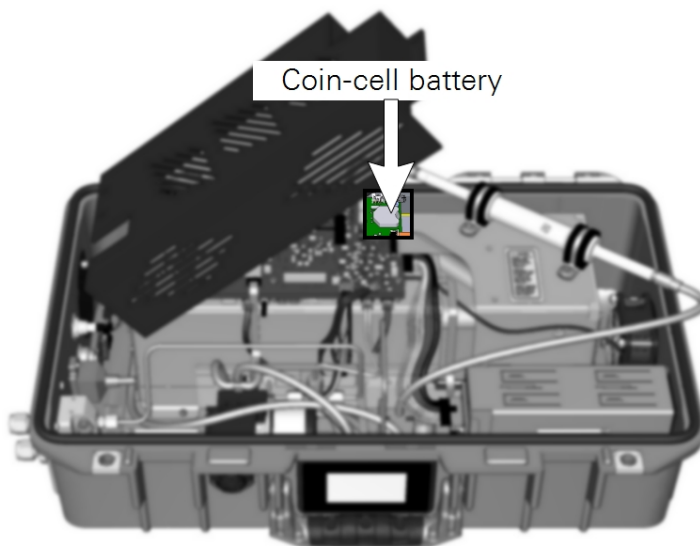

*Figure B-3. Carefully lift the shroud as shown to avoid straining the Wi-Fi antenna, which is attached to the shroud.*





# Appendix C.

## Specifications

---

### General

**Measurement Technique:** OF-CEAS (Optical Feedback – Cavity Enhanced Absorption Spectroscopy)

**Measurement Rate:** 1 sample per second

**Optical Cavity Volume:** 6.41 cm<sup>3</sup>

**Flow Rate:** 250 sccm nominally

**Total Weight:** 11.4 kg (including batteries)

**Case Dimensions:** 51 cm L x 33 cm W x 18 cm H

**Operating Temperature Range:** -25 °C to 45 °C (without solar load, under normal operating conditions)

**Operating Humidity Range:** 0 to 85% RH (non-condensing, without solar load, under normal operating conditions)

**Operating Pressure Range:** 70 to 110 kPa

**Connectivity:** Ethernet and Wi-Fi (not available in some countries)

**Wi-Fi Compatibility:** 2.4 GHz, 802.11g

#### Power Requirements:

**Pins 1 and 5:** 24 VDC Input; 6 Amps

**Pins 3 and 4:** 10.5 to 33 VDC Input; 8 Amps

#### Power Consumption:

**During Steady State Operation:** 22 Watts

**During Warmup** (10.5 to 33 VDC power supply, pins 3 and 4): Up to 90 Watts

**During Warmup** (Universal power supply or 24VDC power supply, pins 1 and 5): Up to 140 Watts with batteries charging

**Power Supply:** Universal power adapter (Input: 100 to 240 VAC, 50 to 60 Hz; Output: 24 VDC)

**Battery Life:** 8 hours typical with 2 batteries

**Pollution Degree:** 2

**Over-voltage Category: II**

**Response Time ( $T_{10}-T_{90}$ ):** CH<sub>4</sub> ≤ 2 seconds from 0 to 2 ppm

### CH<sub>4</sub> Measurements

**Range:** 0.1 to 50 ppm

**Precision ( $1\sigma$ ):** 0.25 ppb with 5 second averaging

**Maximum Drift:** <1 ppb per 24-hour period

### CO<sub>2</sub> Measurements

**Range:** 1 to 10,000 ppm

**Precision ( $1\sigma$ ):** 1.5 ppm with 5 second averaging

### H<sub>2</sub>O Measurements

**Range:** 100 to 60,000 ppm

**Precision ( $1\sigma$ ):** 20 ppm with 5 second averaging

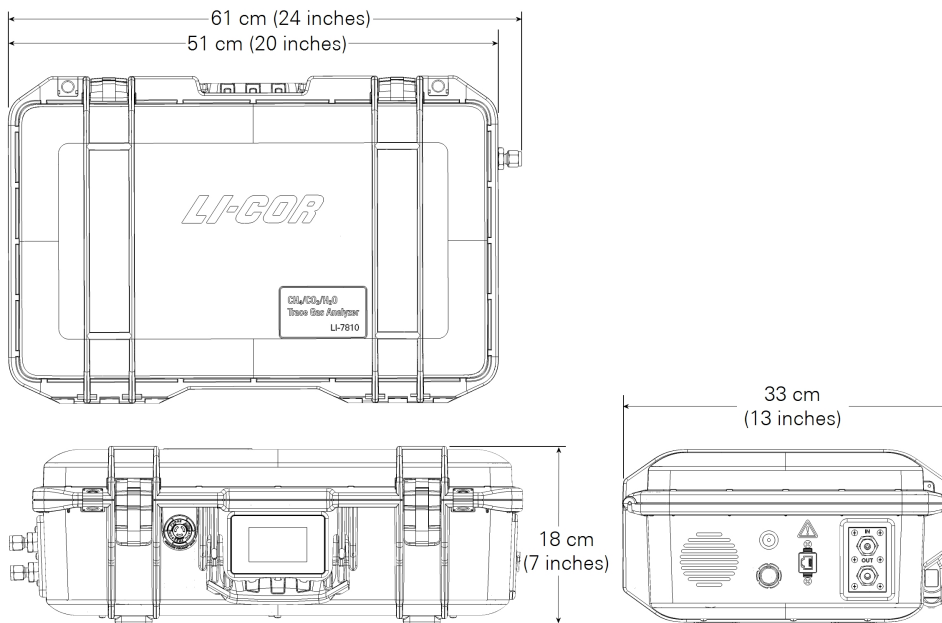

*Figure C-1. LI-7810 dimensions. Clearance is required for the power cable and tubing, as well as 2 to 3 cm around the case vents.*

# Appendix D.

## Warranty

---

Each LI-COR, Inc. instrument is warranted by LI-COR, Inc. to be free from defects in material and workmanship; however, LI-COR, Inc.'s sole obligation under this warranty shall be to repair or replace any part of the instrument which LI-COR, Inc.'s examination discloses to have been defective in material or workmanship without charge and only under the following conditions, which are:

- 1** The defects are called to the attention of LI-COR, Inc. in Lincoln, Nebraska, in writing within one year after the shipping date of the instrument.
- 2** The instrument has not been maintained, repaired or altered by anyone who was not approved by LI-COR, Inc.
- 3** The instrument was used in the normal, proper and ordinary manner and has not been abused, altered, misused, neglected, involved in an accident or damaged by act of God or other casualty.
- 4** The purchaser, whether it is a DISTRIBUTOR or direct customer of LI-COR or a DISTRIBUTOR'S customer, packs and ships or delivers the instrument to LI-COR, Inc. at LI-COR Inc.'s factory in Lincoln, Nebraska, U.S.A. within 30 days after LI-COR, Inc. has received written notice of the defect. Unless other arrangements have been made in writing, transportation to LI-COR, Inc. (by air unless otherwise authorized by LI-COR, Inc.) is at customer expense.
- 5** No-charge repair parts may be sent at LI-COR, Inc.'s sole discretion to the purchaser for installation by purchaser.
- 6** LI-COR, Inc.'s liability is limited to repair or replace any part of the instrument without charge if LI-COR, Inc.'s examination disclosed that part to have been defective in material or workmanship.

**There are no warranties, express or implied, including but not limited to any implied warranty of merchantability of fitness for a particular purpose on underwater cables or on expendables such as batteries, lamps, thermocouples, and calibrations.**

**Other than the obligation of LI-COR, Inc. expressly set forth herein, LI-COR, Inc. disclaims all warranties of merchantability or fitness for a particular purpose. The foregoing constitutes LI-COR, Inc.'s sole obligation and liability with respect to damages resulting from the use or performance of the instrument and in no event shall LI-COR, Inc. or its representatives be liable for damages beyond the price paid for the instrument, or for direct, incidental or consequential damages.**

The laws of some locations may not allow the exclusion or limitation on implied warranties or on incidental or consequential damaged, so the limitations herein may not apply directly. This warranty gives you specific legal rights, and you may already have other rights which vary from state to state. All warranties that apply, whether included by this contract or by law, are limited to the time period of this warranty which is a twelve-month period commencing from the date the instrument is shipped to a user who is a customer or eighteen months from the date of shipment to LI-COR, Inc.'s authorized distributor, whichever is earlier.

This warranty supersedes all warranties for products purchased prior to June 1, 1984, unless this warranty is later superseded. To the extent not superseded by the terms of any extended warranty, the terms and conditions of LI-COR's Warranty still apply.

DISTRIBUTOR or the DISTRIBUTOR's customers may ship the instruments directly to LI-COR if they are unable to repair the instrument themselves even though the DISTRIBUTOR has been approved for making such repairs and has agreed with the customer to make such repairs as covered by this limited warranty.

Further information concerning this warranty may be obtained by writing or telephoning Warranty manager at LI-COR, Inc.

# Appendix E.

## Index

### A

- air filter, 6-4
- alarms, 4-4
- auto sync
  - clock, 4-5

### B

- backpack kit, 1-5
- batteries, 2-6
  - about, 1-3
  - charging, 2-6
  - disposal, B-4
  - warnings, B-4
- battery status, 4-8

### C

- calibration, 4-10, 6-1
  - span, 6-3
  - zero, 6-2
- cavity temperature, 4-9
- channels
  - Wi-Fi, B-3
- Chinese language, 4-10, 5-4
- connecting, 2-1
  - local area network, 2-2
  - wireless, 2-4
- connecting a sample, 3-3
- connecting an air supply, 3-2

- connection issues, 5-1, 5-3

### D

- data
  - retrieving, 3-4
- data files
  - about, 3-4
- date
  - setting, 4-5
- DHCP, 4-6
- dimensions, C-2
- display panel, 2-8
- downloading data, 3-4
- dry-down chemical, 6-5

### E

- English language, 4-10, 5-4
- error codes, 2-9

### F

- factory reset, 4-10
- files
  - data, 3-4
- filter
  - air inlet, 6-4
- flow rate, 4-10

### I

- installing, 3-7

IP address, 2-8, 5-1

## L

LAN, 2-2

language selection, 4-10, 5-4

laser pressure, 4-9

laser safety labels, B-1

laser temperature, 4-9

laser temperature shift, 4-9

## M

mounting, 3-7

## N

network, 4-5, 4-6

network status, 4-8

network time protocol, 4-5

NTP, 4-5

## O

OF-CEAS, 1-1, A-1

## P

performance status, 4-8

power supply, 1-3, 2-6

powering on and off, 1-2, 2-1, 2-10

precision time protocol, 4-6

PTP, 4-6

purge, 6-5

## R

residual, 4-9

ring down time, 4-9

## S

safety labels

laser, B-1

serial number, 2-8

set IP address automatically, 4-6

settings, 4-8

shipping the LI-7810, 2-11

size, C-2

software

updating, 4-5

software interface, 4-1

software version, 4-5

span calibration, 4-10, 6-3

Spanish language, 4-10, 5-4

specifications, C-1

spectroscopy, 1-1, A-1

static IP address, 4-6

status

battery, 4-8

network, 4-8

performance, 4-8

status codes, 2-9

storing, 2-10

## T

thermal enclosure temperature, 4-9

thresholds, 4-4

time

setting, 4-5

unix epoch, 3-6

timezone, 3-5, 3-6

troubleshooting, 5-1

## W

warnings, B-1

Wi-Fi, 4-6, B-3

wireless communication, B-3

wireless networking, 4-6

## Z

zero calibration, 4-10, 6-2



**LI-COR Biosciences**

4647 Superior Street  
Lincoln, Nebraska 68504  
Phone: +1-402-467-3576  
Toll free: 800-447-3576 (U.S. and Canada)  
envsales@licor.com

***Regional Offices*****LI-COR Biosciences GmbH**

Siemensstraße 25A  
61352 Bad Homburg  
Germany  
Phone: +49 (0) 6172 17 17 771  
envsales-gmbh@licor.com

**LI-COR Biosciences UK Ltd.**

St. John's Innovation Centre  
Cowley Road  
Cambridge  
CB4 0WS  
United Kingdom  
Phone: +44 (0) 1223 422102  
envsales-UK@licor.com

**LI-COR Distributor Network:**

[www.licor.com/env/distributors](http://www.licor.com/env/distributors)

984-17414 • 03/19

The LI-COR logo is displayed in a bold, italicized, white sans-serif font against a solid blue background. The letters are closely spaced, and a registered trademark symbol (®) is located at the bottom right of the word "COR".